



TOOL PRESETTERS & TIGHTENING FIXTURES

Sect: B of 2015 Machine Tool Accessories Catalog

Precision, Performance & Efficiency!



Dorian Tool's First Choice Technology offers tool presetting and data management to increase your shop's productivity.

Ranging from entry-level to high-end machines, Dorian Tool presetters give you the high precision and repeatability you need to maximize your manufacturing capabilities, and minimize cost and machine downtime with **three presetter models:**

QuiK-SET™ Tool Presetter

for small footprint and heavy-duty environments

ACCU-SET PLUS™ Tool Presetter

for highest precision and repeatability

Vision-SET™ Tool Presetter

for maximum precision and tool data management

User-friendliness, high precision, easy setup, and a very competitive price make Dorian presetters the most versatile in the market.

Quick Selection Chart:

Based off your precision and tooling needs, use the chart on page G-3 to select a Dorian presetter that will best fit your presetting needs.

All Dorian Tool presetters have interchangeable CAT, BT, ISO, and HSK tapers, without the need of an adapter.



QuiK-SET™ Tool Presetter

- Heavy Duty Steel Base
- Reduces Setup Time
- Excellent Precision & Repeatability
- CAT, BT, HSK, ISO and VDI Interchangeable Sleeves
- Built For Shop Environment

Page G-4-G-5



Model	Height Capacity	Diameter Capacity	Resolution	Accuracy
QuiK-SET Z300	12.00in (300mm)	10.00in (250mm)	.0005in (0,010mm)	±.0005in (0,010mm)
QuiK-SET Z400	15.75in (400mm)	10.00in (250mm)	.0005in (0,010mm)	±.0005in (0,010mm)
QuiK-SET XM	12.00in (300mm)	15.75in (400mm)	.0005in (0,010mm)	±.0005in (0,010mm)
QuiK-SET Z600	23.62in (600mm)	23.62in (600mm)	.0005in (0,010mm)	±.0005in (0,010mm)

ACCU-SET PLUS™ Tool Presetter

- Easy to Operate
- Fast & Precise
- Reduces Setup Time
- Rigid, All- Steel Construction
- High Precision Linear Guides and Bearings
- CAT, BT, HSK, ISO and VDI Interchangeable Sleeves

Page G-6-G-7



Model	Height Capacity	Diameter Capacity	Resolution	Accuracy
Accu-SET Z300	12.00in (300mm)	10.00in (250mm)	.00005in (.001mm)	± .0002in (.005mm)
Accu-SET Z400	15.75in (400mm)	10.00in (250mm)	.00005in (.001mm)	± .0002in (.005mm)

Vision-SET™ Tool Presetter

- User-friendly interface
- High-precision optical scales with .00004in/.001mm resolution
- Geometric functions to measure angles, distances, radii, & more
- Powerful Post-processor to import tool data to your CNC
- Insert profiler to track cutting edge wear
- Take screenshots and save to PDF
- Storage capacity for 200 machine origins and 20,000 tools
- Simple tool offset setting
- CAT, BT, ISO, HSK, and VDI interchangeable tool sleeves (pots)
- Label printer for easy tool identification
- Software Update through Ethernet

Page G-8-G-11



Model	Height Capacity	Diameter Capacity	Resolution	Accuracy
Vision-SET 360	14.00in (360mm)	12.50in (320mm)	.00005in (.001mm)	± .0002in (.005mm)
Vision-SET 500	19.50in (500mm)	12.50in (320mm)	.00005in (.001mm)	± .0002in (.005mm)
Vision-SET 360XM	14.00in (360mm)	20.50in (520mm)	.00005in (.001mm)	± .0002in (.005mm)
Vision-SET 500XM	19.50in (500mm)	20.50in (520mm)	.00005in (.001mm)	± .0002in (.005mm)

QuiK-SET™ Tool Presetter

Features

- Reduces Setup Time
- Excellent Precision & Repeatability
- Absolute Incremental Mode
- Diameter/radius Mode
- Inch or Metric Reading
- Best Technology
At The Lowest Price In The Industry
- Built For Shop Environment

Precision

- Resolution .0005in (0.10mm)
- Accuracy \pm .0005in (0.10mm)
- Repeatability .0005in (0.10mm)
- Axis Squareness .0002in (.005mm) TIR

Hardware

- All Heat Treated Components
- Recirculating Ball Bearing and Linear Guide
- Powered by AA Batteries
- Heavy Duty Steel Base
- CAT, BT, HSK, ISO and VDI
Interchangeable Sleeves

The QuiK-SET™ Tool Presetter is a precision instrument designed for speed and simplicity in manufacturing environments or tool cribs.

This model has been carefully designed to meet the needs of the CNC machine operator. Its portability and ruggedness make this the best presetter for small machining cells.

The pre-loaded recirculating ball bearing guide in the X-axis allows for accurate and smooth positioning to measure the tool's diameter, while the Z-axis display can be locked to preset tool lengths quickly and precisely.

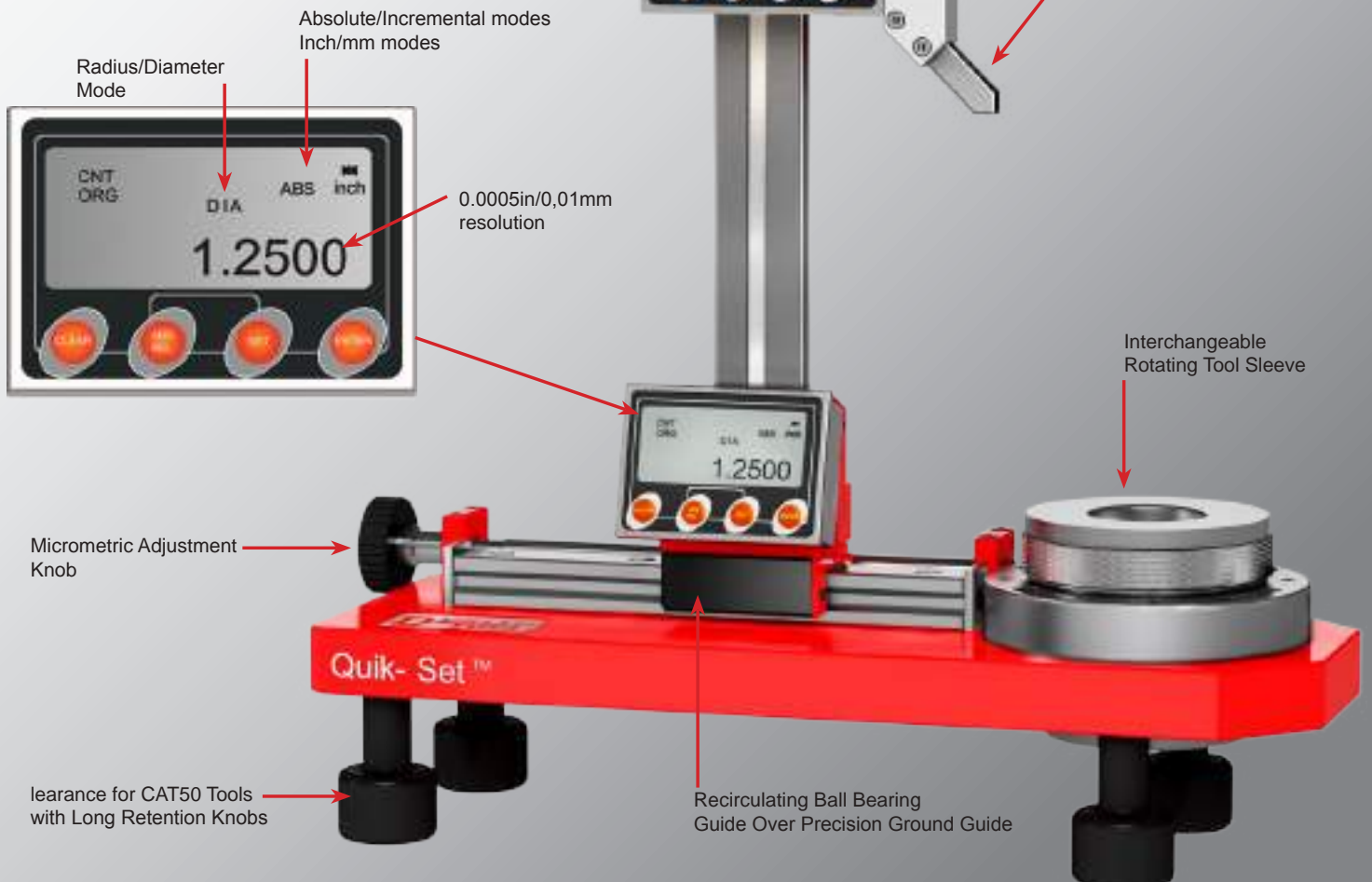

QuiK-SET™ Tool Presetter Specifications



Measure the tool diameter



Measure the tool length



Lock the Z-axis for quick length adjustment



Rotating interchangeable sleeve, with adjustment screws for parallel calibration

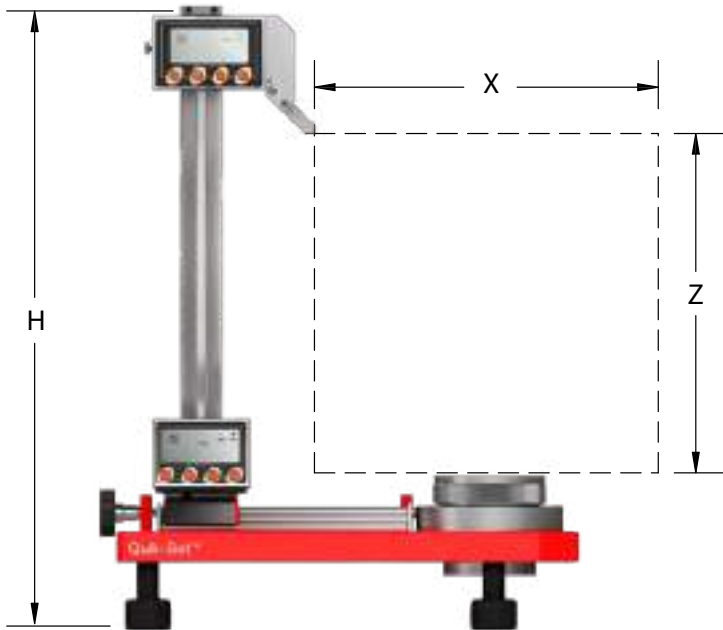

UPC 733101-	42001	42030	42032	42034
QuiK-SET	Z300	Z400	XM	Z600
Accuracy	±.0005 (0,010mm)			
Height Capacity (Z)	12.0in (300mm)	15.8in (400mm)	12.0in (300mm)	23.6in (600mm)
Diameter Capacity (X)	10.0in (250mm)	10.0in (250mm)	15.8in (400mm)	23.6in (600mm)
Presetter Height (H)	23.6 (600mm)	27.6in (700mm)	PENDING	36.2in (920mm)
Presetter Length (L)	15.8in (400mm)	15.8in (400mm)	PENDING	23.2in (590mm)
Presetter Width (W)	5.7in (145mm)	5.7in (145mm)	PENDING	7.7in (195mm)
Measuring Method	Contact Probe			
Power Input	AA Batteries			
Warranty	One Year*			

QuiK-SET Optional Tool Sleeves			
Style	BT30	CAT/BT50	HSK63A-63C
UPC 733101-	42066	42070	42078

SUPPLIED STANDARD WITH CAT/BT40 TOOL SLEEVE

ACCU-SET PLUS™ Tool Presetter

Features

- Easy to Operate
- Tool Storage and Machine Origins
- Alphanumeric Keys for Tool Identification
- Hold Function

Precision

- Resolution .00005in (.001mm)
- Accuracy $\pm .0002$ in (.005mm)
- Repeatability $\pm .0002$ in (.005mm)
- Axis Squareness .0002in (.005mm) TIR

Hardware

- Rigid, All- Steel Construction
- High Precision Linear Guides and Bearings
- Heat Treated Components
- Spring Loaded Indicator will not Damage Cutters Edge
- CAT, BT, HSK, ISO and VDI Interchangeable Sleeves

The ACCU-SET PLUS™ Tool Presetter is the result of our pursuit of high technology while striving to maintain simplicity of use. Rigidity, precision, and repeatability are all standard on this high precision presetter.

The ease of moving the two axes simultaneously with one hand and the notable rigidity of the instrument make the presetter extremely simple, fast, and precise in positioning the measuring probe on the tool.

The pre-loaded ball bearing guides guarantee the same contact force between the probe and the tool.



ACCU-SET PLUS™ Tool Presetter Specifications



Measure the tool diameter



Measure the tool length



Spring Loaded indicator for reference, with hardened steel tip



Rotating interchangeable sleeve, with adjustment screws for parallel calibration

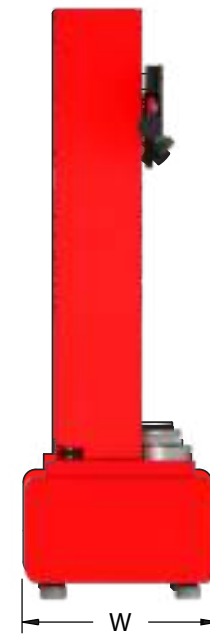
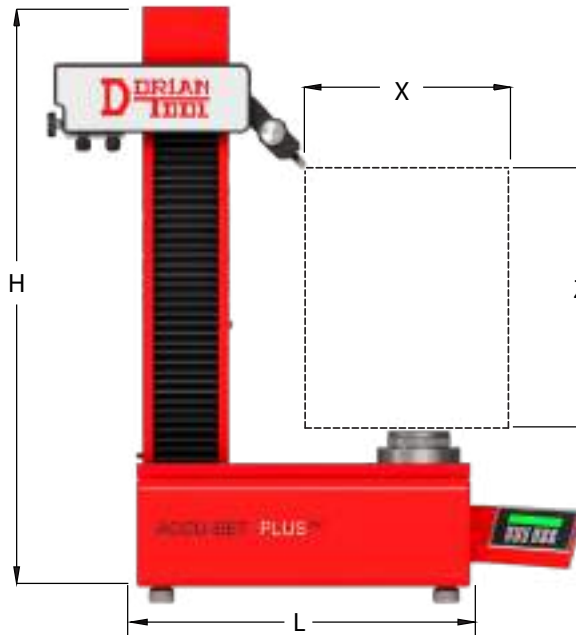

UPC 733101-	42007	42009
Accu-SET PLUS	Z300	Z400
Accuracy	±.0002 (0,005mm)	
Height Capacity	12.00in (300mm)	15.75in (400mm)
Diameter Capacity	10.00 (250mm)	
Presetter Height (H)	30.7in (780mm)	35.4in (900mm)
Presetter Length (L)	18.5in (470mm)	
Presetter Width (W)	11.4in (290mm)	
Measuring Method	Spring Loaded Contact Probe	
Measuring Device	High Precision Scale	
Machine Origins	100	
Tool Memory	9900 tools	
Power Input	110V AC	
Warranty	One Year*	

SUPPLIED STANDARD WITH CAT/BT40 TOOL SLEEVE

Accu-SET PLUS Optional Tool Sleeves			
Style	BT30	CAT/BT50	HSK63A-63C
UPC 733101-	42066	42070	42078

Accu-SET PLUS Optional Stand (Shown Below)	
Size	34in (H) x 22in (W) x 32in (L)
UPC 733101-	42045



Vision-SET™ Tool Presetter

Software

- User-friendly interface Software
- Simple tool offset setting
- Insert profiler to track cutting edge wear
- Geometric functions to measure angles, distances, radii, and many more
- Powerful Post-processor to import tool data to your CNC
- Take screenshots and save to PDF for future reference
- Storage capacity for 200 machine origins and 20,000 tools
- Label printer for easy tool identification
- Software Update through Internet Connection (Ethernet)

Peripherals

- 17in Color Monitor
- 40 x magnification CMOS Camera
- Ethernet/USB Output/input

Precision

- Resolution .00005in (.001mm)
- Accuracy $\pm .0002$ in (.005mm)
- Repeatability $\pm .0002$ in (.005mm)
- Axis Squareness .0002in (.005mm) TIR

Hardware

- High-precision optical scales with .00005in/.001mm resolution
- CAT, BT, ISO, HSK, and VDI Interchangeable tool sleeves (pots)
- Easy to replace tool sleeves (with no adapters) and locking knob for tool adjustment
- All Heat Treated Components
- Recirculating Ball Bearing Linear Guides



Vision-SET™ Tool Presetter Specifications

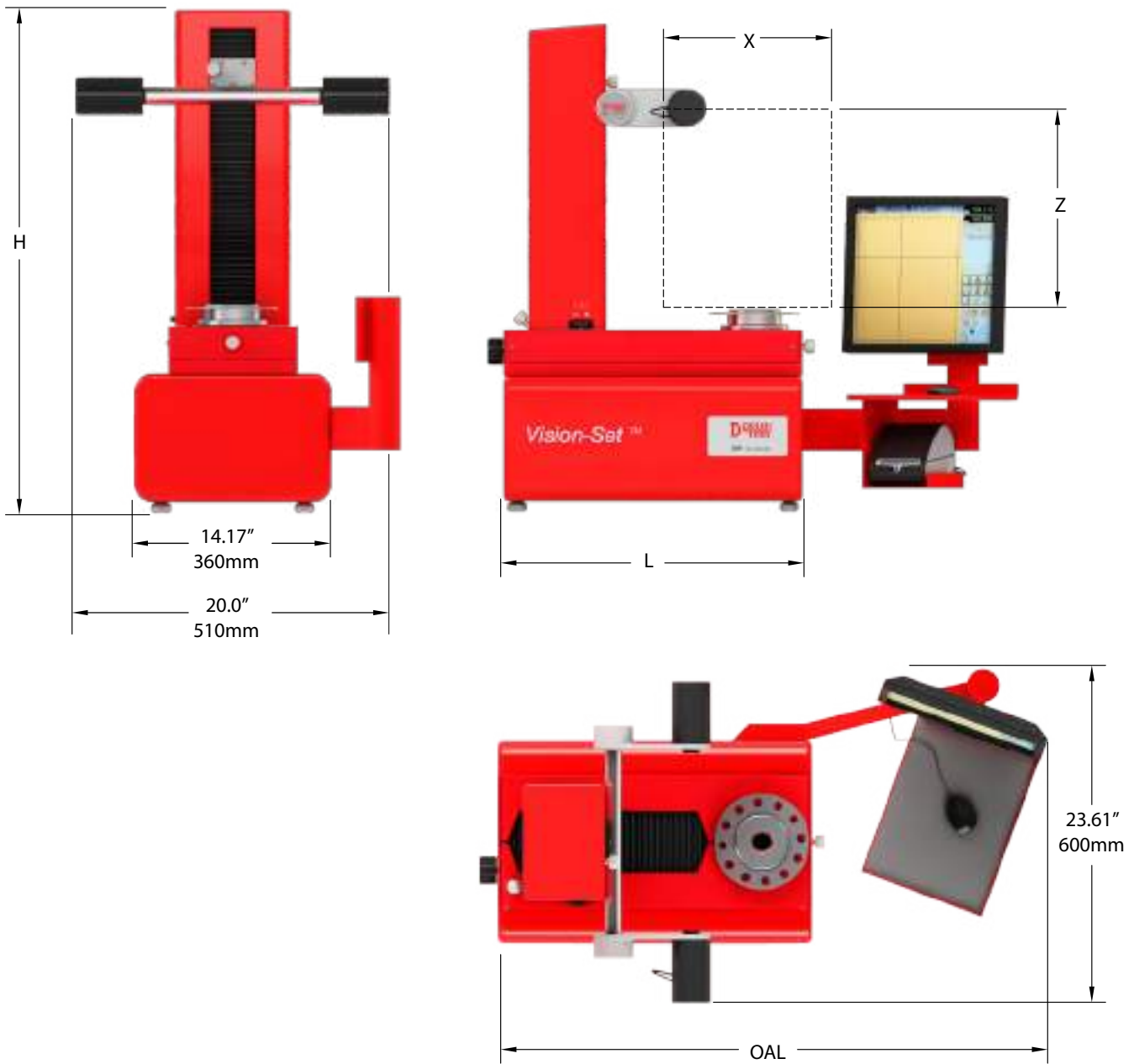

UPC 733101-	42022	42024	42026	42028
Vision-SET	360	500	360XM	500XM
Accuracy	±.0002 (0,005mm)			
Height Capacity (Z)	14.0in (360mm)	19.5in (500mm)	14.0in (360mm)	19.5in (500mm)
Diameter Capacity (X)	12.5in (320mm)	12.5in (320mm)	20.5in (520mm)	20.5in (520mm)
Presetter Height (H)	37.4in (950mm)	43.3in (1100mm)	37.4in (950mm)	43.3in (1100mm)
Presetter Length (L)	22.0in (560mm)		26.0in (660mm)	
Presetter OAL	39.0in (990mm)		42.9in (1090mm)	
Measuring Method	CMOS High Resolution Camera			
Measuring Device	High Precision Optical Scales			
Machine Origins	Up to 200			
Tool Memory	20,000			
Included Accessories	Post-processor, Dymo Label Printer			
Power Input	110V AC			
Warranty	One Year*			

Vision-SET Optional Tool Sleeves			
Style	BT30	CAT/BT50	HSK63A-63C
UPC 733101-	42105	42106	42107

Vision-SET Optional Stand (Shown Below)	
Size	34in (H) x 22in (W) x 32in (L)
UPC 733101-	42045



SUPPLIED STANDARD WITH CAT/BT40 TOOL SLEEVE

Vision-SET™ Tool Presetter Connectivity

The Vision-Set's Powerful post-processor will help you minimize machine downtime, hence improving your shops efficiency. Save all your tool information and export to different media or upload directly to your computer DSN. Print labels and tools list for any job and for future reference.

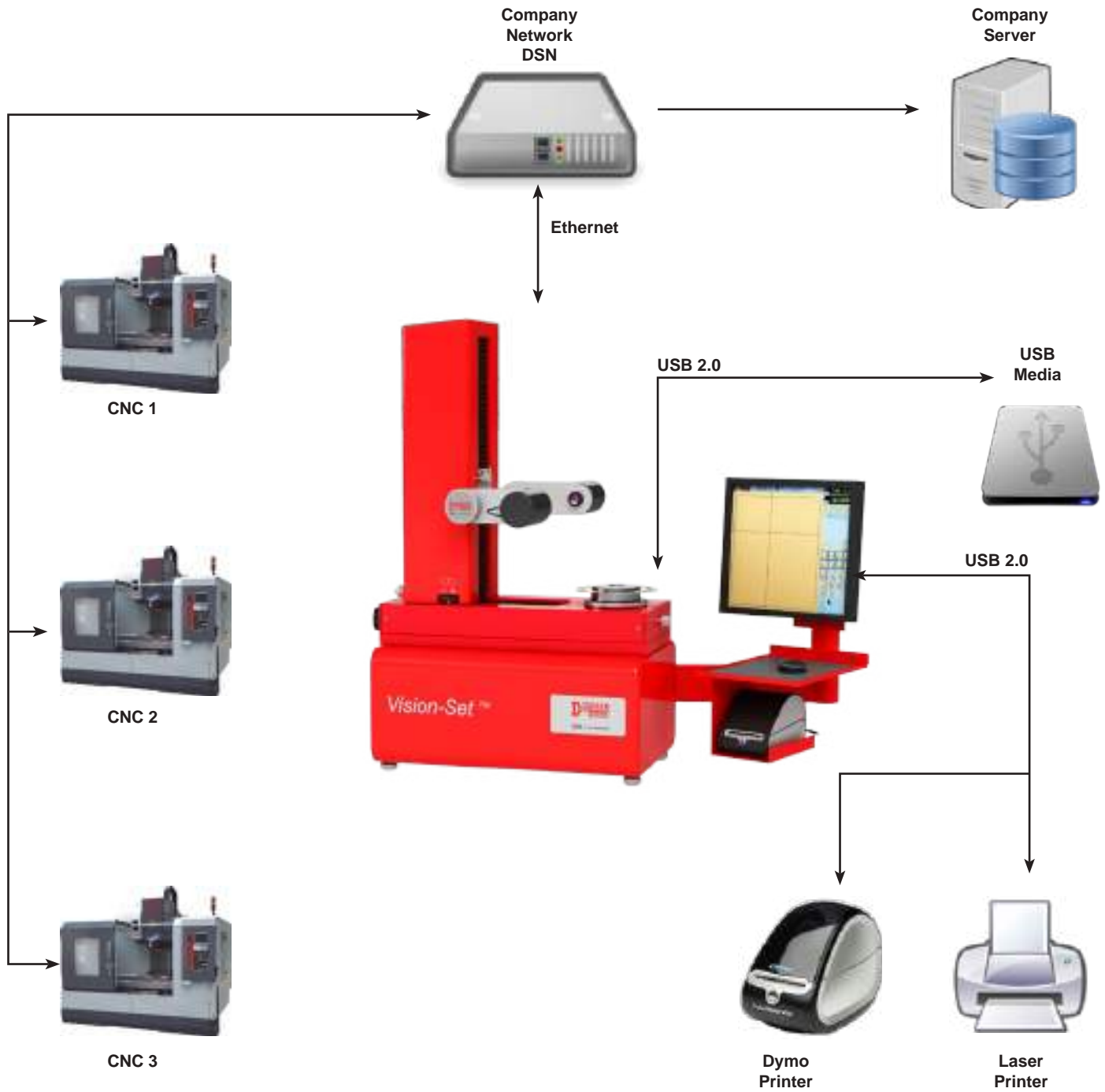

Vision-SET™ Tool Presetter Software

- Measure your tools in seconds
- Identify and highlight possible geometries to measure
- List more information like center positions and intersections
- All graphic user interface with on-screen keyboard or connect USB keyboard
- Absolute and incremental modes
- Fixed/Tracking/User-defined axis mode
- 20+ Geometrical functions to measure radii, angles, intersections, multiple edges, etc.
- Surface inspection tool to track cutter wear

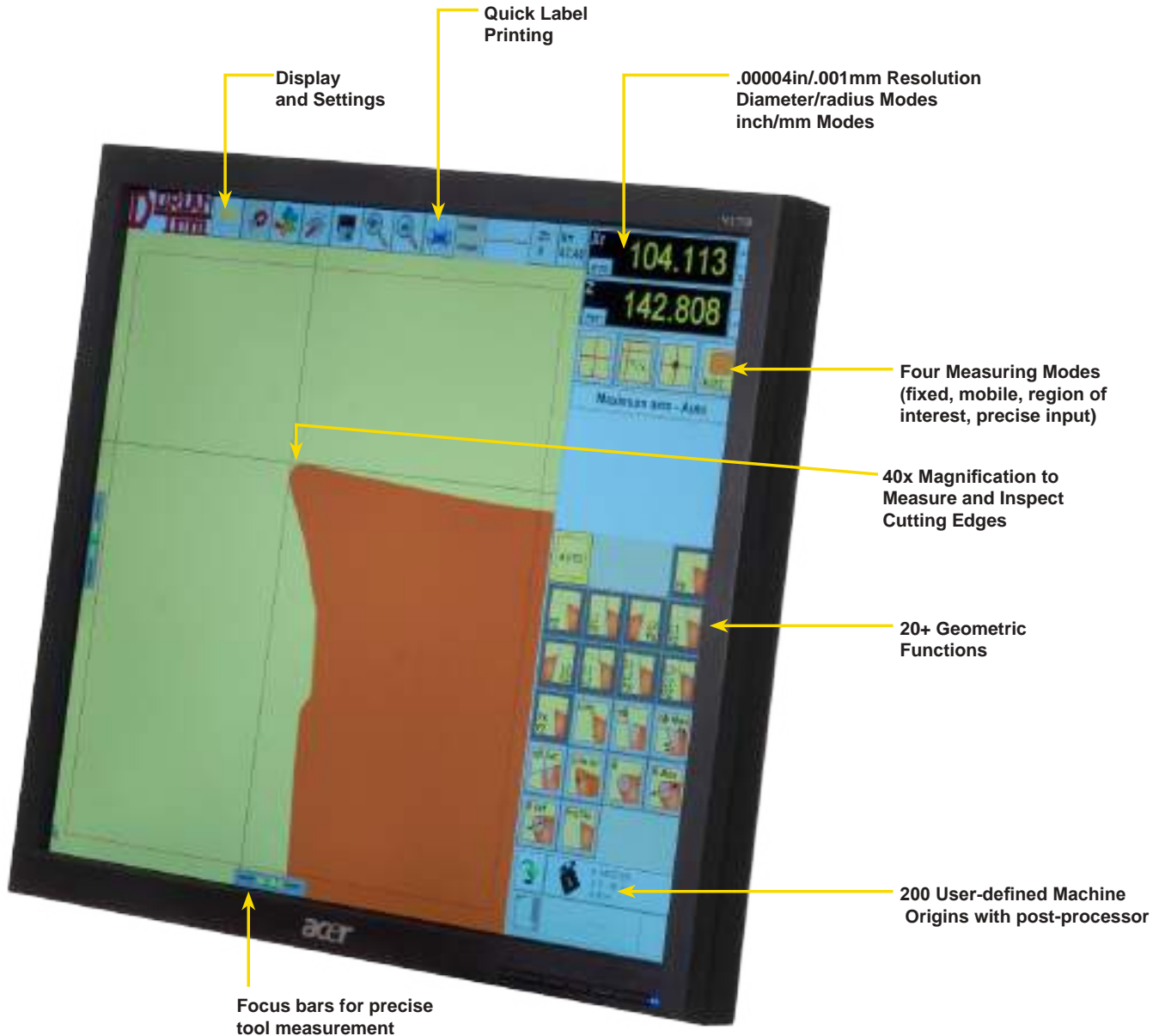

Smart Tool-Setter Tightening Fixture

Intelligent • Dependable • Productive

Heavy Duty & Versatile



UPC 733101-	Description	Tool Size
36000	DSTSCH-030	BT-30
36001	DSTSCH-040	BT-40 CAT-40
36002	DSTSCH-050	BT-50 CAT-50
36003	DSTSHSK-063	HSK-063
36004	DSTSHSK-100	HSK-100

Toolholder Taper Protected From Chips & Scratches

- Teflon Based Xylan Coating
- Quick Lock & Setting
- Multi-Position Setting
- Heavy Duty Construction
- Precise Quality & Workmanship
- Multi-Functional
- Holds CAT, BT or HSK Toolholders

Mounting



Mount the Smart Tool-Setter on a solid workbench. Use the 4 holes provided on the base to bolt down the Smart Tool-Setter.

Holder Loading



Put holder in while locking knob is in unlocked position. Rotate locking knob to locked position to lock holder on the inVin groove located on the diameter of the holder. Locking knob positively locks the tool in and does not allow tool to come out of place.

Application

The Smart Tool-Setter's precise and heavy duty construction make the tool-setter very rigid and able to endure extreme forces without causing any damage to tools or the Smart Tool-Setter. The multi-functioning and positioning of the Smart Tool-Setter allow the operator to switch quickly and easily from one operation to another without loss of time.

Small Tool Change



Endmills can be easily, quickly, and precisely set with the Smart Tool-Setter.

Large Tool Change



Large tools can be mounted or removed with the Smart Tool-Setter.

Positioning



Pull the indexing knob to unlock, turn into a new position, and release the

Pull Stud Change



Pull Studs can be quickly and easily changed using the Smart Tool-Setter.