



The First Choice
TECHNOLOGY

Knurling Tools

for Cutting & Forming



Section: H of 2016 Indexable Cutting Tools

Knurling Tools & Wheels

Technical Support

Knurling Tools Applications Form for Manual & CNC Machines

Knurling Tools Terminology

Knurling Tools Technical Data

Knurling Tools Tooth & Pitch Calculations

Knurling Pattern Information

Knurling Tools Proper Print Dimensions

Knurling Tools Diametral Knurling Information

Knurling Tools Knurled Diameters

Knurling Tools Speeds & Feeds

Common Knurling Problems

Knurling Tools Forming Operation Instructions

Knurling Tools Cutting Operation Instructions

Application for Clean, Well-formed Knurl or Serrations

Mathematical Conversion Factors

Metric Conversion Formula and Tables

Safety Precautions & Product Hazards

Knurling Tools For CNC and Manual Lathes

Graphic Index

Knurling Tools Identification Chart

Knurl Wheels

Knurling Wheels Identification System

Knurling Wheels Technology

Knurling Wheels Series Selection

Knurling Tools Spare Parts

Spare Parts



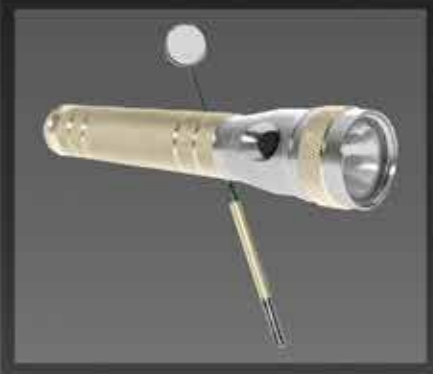

The Possibilities are **ENDLESS** with

DORIAN[®]
TOOL

Knurling Tools



Knurling Tools & Wheels

<p>CNC Modular Shank for Standard Series Modular Knurling Heads</p>  <p>Page H-28</p>	<p>CNC Modular Shank for SMALL Series Modular Knurling Heads</p>  <p>Page H-32</p>	<p>SWFKT Single Wheel Fixed Knurling Tool HDSWFKT Heavy Duty Single Wheel Fixed Knurling Tool</p>  <p>Page H-40</p>	<p>KTM109 Heavy Duty Style Straddle Square Shank Knurling Tool 1.5" & 2.5" Diameter Range</p>  <p>Page H-48 (See page for Interchangeable Arms)</p>
<p>CNC-1-2 1 - Light Duty 60° Diamond Cutting Knurling Head</p>  <p>Page H-28</p>	<p>SCNC-1-2 1-SMALL Light Duty 60° Diamond Cutting Knurling Head</p>  <p>Page H-33</p>	<p>SSWFKT Single Shoulder Wheel Fixed Knurling Tool</p>  <p>Page H-42</p>	<p>KTW109 Shoulder Style Straddle Square Shank Knurling Tool 1.5" & 2.5" Diameter Range</p>  <p>Page H-49 (See page for Interchangeable Arms)</p>
<p>CNC-2-R 2 - Heavy Duty 60° Diamond Cutting Knurling Head</p>  <p>Page H-28</p>	<p>SCNC-6-2 6- SMALL Shoulder Forming Knurling Head</p>  <p>Page H-33</p>	<p>FKT Fixed Knurling Tool</p>  <p>Page H-41</p>	<p>KTO109 Heavy Duty Style Straddle Square Shank Knurling Tool 4.0" Diameter</p>  <p>Page H-50 (See page for Interchangeable Arms)</p>
<p>CNC-3-M 3 - Extra Heavy Duty 60° Diamond Cutting Knurling Head</p>  <p>Page H-28</p>	<p>SCNC-7-D 7- SMALL Straddle Forming Knurling Head</p>  <p>Page H-33</p>	<p>SFKT Shoulder Fixed Knurling Tool</p>  <p>Page H-43</p>	<p>KTW109-40 Shoulder Style Straddle Square Shank Knurling Tool 4.0" Diameter Range</p>  <p>Page H-51 (See page for Interchangeable Arms)</p>
<p>CNC-4-M 4- Double Wheel Forming Knurling Head</p>  <p>Page H-29</p>	<p>SCNC-8-2 7- SMALL Straddle Forming Knurling Head</p>  <p>Page H-33</p>	<p>SCKN Self Centering Knurling Tool HDSCKN Heavy Duty Self Centering Knurling Tool</p>  <p>Page H-38</p>	<p>CNC109-M Side Mount Flange Square Shank Knurling Tool 1.5 & 2.5 Diameter Range</p>  <p>Page H-52 (See page for Interchangeable Arms)</p>
<p>CNC-5-O 5- Single Wheel Forming Knurling Head</p>  <p>Page H-29</p>	<p>107ST Straight Cutting Knurling Tool</p>  <p>Page H-34</p>	<p>SSCK Shoulder Self Centering Knurling Tool</p>  <p>Page H-39</p>	<p>CNC109-4 Side Mount Shoulder Square Shank Knurling Tool 1.5 & 2.5 Diameter Range</p>  <p>Page H-53 (See page for Interchangeable Arms)</p>
<p>CNC-6-4 6- Shoulder Forming Knurling Head</p>  <p>Page H-29</p>	<p>107ST Straight Cutting Shoulder Knurling Tool</p>  <p>Page H-35</p>	<p>TIKT True Internal Knurling Tool</p>  <p>Page H-44</p>	<p>3WKT Three Wheel Knurling Tool</p>  <p>Page H-57</p>
<p>CNC-7-R 7- Straddle Forming Knurling Head</p>  <p>Page H-29</p>	<p>3SHKT Three Swivel Head Forming Knurling Tool</p>  <p>Page H-37</p>	<p>SIKT Shoulder Internal Knurling Tool</p>  <p>Page H-45</p>	<p>Knurling Wheels</p>  <p>Page H-60</p>
<p>CNC-8-2 7- Straddle Forming Knurling Head</p>  <p>Page H-29</p>	<p>FACEKT Single Wheel Face Forming Knurling Tool</p>  <p>Page H-36</p>	<p>MMKT Milling Machine Knurling Tool</p>  <p>Page H-46</p>	<p>Spare Parts</p>  <p>Page H-71</p>

Knurling Tools Applications Form for Manual & CNC Machines



If your knurling application is not in the chart, please supply prints and information.

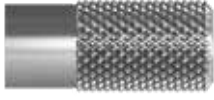

Knurling Application Knurling Tool Recommendation

Knurling Application	BEST	BETTER	GOOD
Diamond Shoulderless 	SCNC-_1-2	SCNC-_7-D	SCKN-_DW_
	CNC-_1-2	CNC-_7-R	3SHKT-_
	CNC-_2-R	KTM109-_M	CNC-_4-M
	CNC-_3-M	KTO109-_O	
	3WKT-_	3SHKT-_	

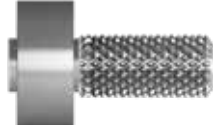
Knurling Application	BEST	BETTER	GOOD
Diamond to a Shoulder 	SCNC-_6-2	KT109-_4	SCCK-_DW_
	CNC-_6-4		KTM-109-_M
	3WKT-_		

Knurling Application	BEST	BETTER	GOOD
Diamond Band 	SCNC-_7-D	SCKN-_DW_	SFKT-_
	CNC-_7-R	3SHKT-_	SWKT-_
	KTM109-_M		
	KTO109-_O		
	CNC-_4-M		
Straight Band 	CNC-_5-O		

Knurling Application	BEST	BETTER	GOOD
Small Diameter Diamond to a Shoulder 	3WKT-_		
Small Diameter Straight to a Shoulder 			

Knurling Application	BEST	BETTER	GOOD
Diamond Crest 	SCNC-_7-D	SCKN-_DW_	SFKT-_
	CNC-_7-R	3SHKT-_	SWKT-_
	KTM109-_M		
	CNC-_4-M		
	CNC-_5-O		
Straight Crest 			



Knurling Application	BEST	BETTER	GOOD
Radio Face 	Special		



Knurling Application Knurling Tool Recommendation

Knurling Application	BEST	BETTER	GOOD
Straight Shoulderless 	SCNC-_7-D	107ST-_	CMC-_5-O
	CNC-_7-R	107ST-_	SWKT-_
	KTM109-_M	CNC-_4-M	
	KTO109-_O	SCKN-_DW_	
	3WKT-_		

Knurling Application	BEST	BETTER	GOOD
Straight to a Shoulder 	KTW109-_4	SCNC-_6-2	FKT-_
	3WKT-_	CNC-_6-4	

Knurling Application	BEST	BETTER	GOOD
Small Diameter Diamond Shoulderless 	3WKT-_	SCNC-_7-D	SFKT-_
		CNC-_7-R	SWFKT-_
Small Diameter Straight Shoulderless 			

Knurling Application	BEST	BETTER	GOOD
Taper Diamond 	Special		
Taper Straight 			

Knurling Application	BEST	BETTER	GOOD
Internal Diamond 	TIKT-_		
	SIKT-_		
Internal Straight 			

Knurling Application	BEST	BETTER	GOOD
Milling Diamond 	MMKT-_		
Milling Straight 			

Figure 1 - Full Knurling

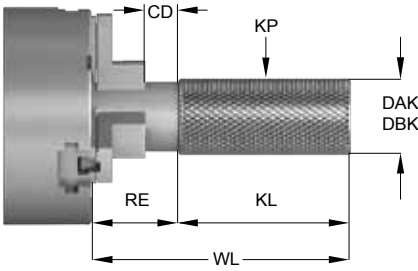

Figure 2 - Band Knurling

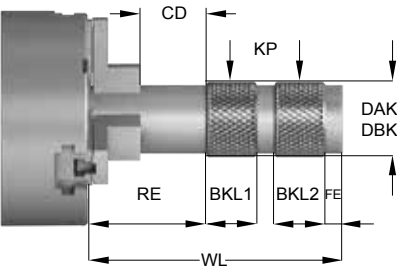

Figure 3 - Shoulder Knurling

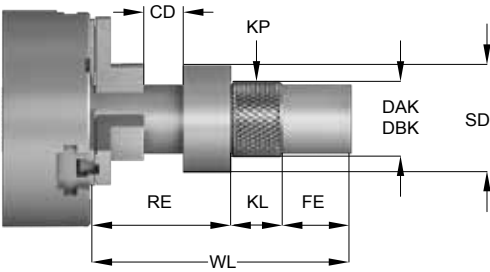
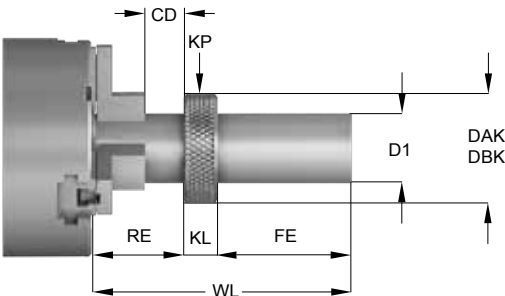
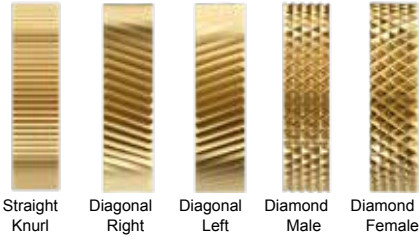

Figure 4 - Crest Knurling



Knurl Wheel Identification



Edge Prep

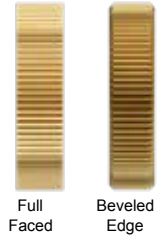

Knurl Pitch

TPI Is the number of teeth per inch

Circular Pitch Is the distance between tooth to tooth

Diametral Pitch Is the number of teeth per inch of diameter

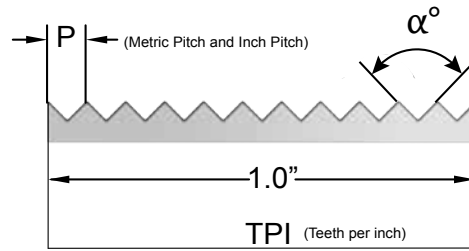

Knurling Specification

x Check Knurling Specification

- | | | | |
|----------------------------------|--------------------------|----------------------------------|--------------------------|
| SKP Straight Knurl | <input type="checkbox"/> | DKPM Diamond Knurl Male | <input type="checkbox"/> |
| DKPR Diagonal Knurl Right | <input type="checkbox"/> | DKPF Diamond Knurl Female | <input type="checkbox"/> |
| DKPL Diagonal Knurl Left | <input type="checkbox"/> | | |

Fill Knurling Dimension

- | | | | | |
|---|---------------------------------|-------------------------------|---|--------------------------|
| KP Knurl Pitch | <input type="checkbox"/> Inch | <input type="checkbox"/> TPI | <input type="checkbox"/> AP % of Knurl Depth | <input type="checkbox"/> |
| | <input type="checkbox"/> DP | <input type="checkbox"/> | | |
| | <input type="checkbox"/> Metric | <input type="checkbox"/> P-mm | | |
| DBK Diameter (Blank) Before Knurling | <input type="checkbox"/> | FE Front End Distance | <input type="checkbox"/> | |
| DAK Diameter After Knurling | <input type="checkbox"/> | RE Rear End Distance | <input type="checkbox"/> | |
| KL Knurling Length | <input type="checkbox"/> | CD Chuck Distance | <input type="checkbox"/> | |
| BKL1 Band Knurling Length 1 | <input type="checkbox"/> | SD Shoulder Diameter | <input type="checkbox"/> | |
| BKL2 Band Knurling Length 2 | <input type="checkbox"/> | D1 Shoulder Diameter | <input type="checkbox"/> | |
| WL Workpiece Length | <input type="checkbox"/> | | | |

Figure 5 - ID Internal Knurling

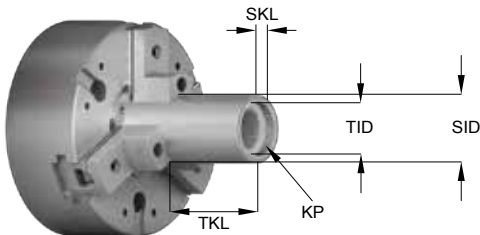

Knurling Specification

Fill Knurling Dimension

TID True Internal Diameter	<input type="text"/>	SKL Shoulder Knurling Length	<input type="text"/>
SID Shoulder Internal Diameter	<input type="text"/>	KP Knurl Pattern	<input type="text"/>
TKL True Knurling Length	<input type="text"/>	PI Knurl Pitch	<input type="text"/> Inch <input type="text"/> TPI <input type="text"/>
			<input type="text"/> DP <input type="text"/>
			<input type="text"/> Metric <input type="text"/> P-mm <input type="text"/>

Figure 6 - Face Knurling

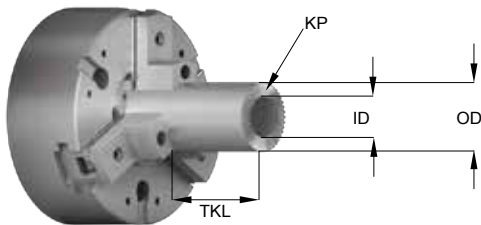

Knurling Specification

Fill Knurling Dimension

ID Inside Diameter	<input type="text"/>	KP Knurl Pattern	<input type="text"/>
OD Outside Diameter	<input type="text"/>	PI Knurl Pitch	<input type="text"/> Inch <input type="text"/> TPI <input type="text"/>
			<input type="text"/> DP <input type="text"/>
			<input type="text"/> Metric <input type="text"/> P-mm <input type="text"/>

Figure 7 - Taper Knurling

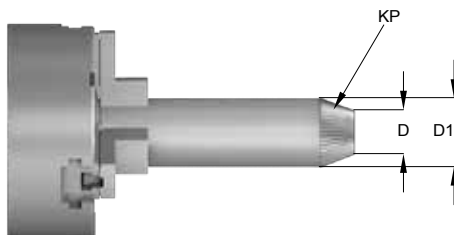

Knurling Specification

Fill Knurling Dimension

D Small Diameter	<input type="text"/>	KP Knurl Pattern	<input type="text"/>
D1 Large Diameter	<input type="text"/>	PI Knurl Pitch	<input type="text"/> Inch <input type="text"/> TPI <input type="text"/>
			<input type="text"/> DP <input type="text"/>
			<input type="text"/> Metric <input type="text"/> P-mm <input type="text"/>

Figure 8 - Milling Knurling

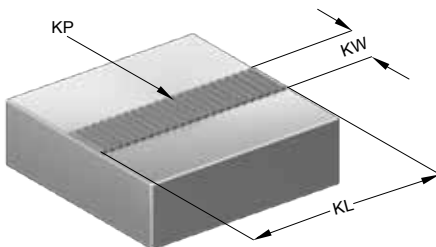













Knurling Specification

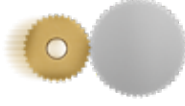

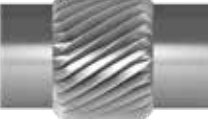

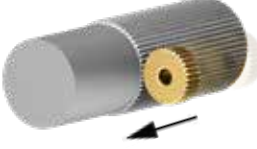

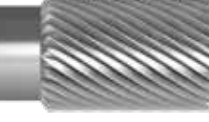



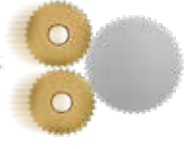

Fill Knurling Dimension

KW Knurling Width	<input type="text"/>	KP Knurl Pattern	<input type="text"/>
KL Knurling Length	<input type="text"/>	PI Knurl Pitch	<input type="text"/> Inch <input type="text"/> TPI <input type="text"/>
			<input type="text"/> DP <input type="text"/>
			<input type="text"/> Metric <input type="text"/> P-mm <input type="text"/>

Knurling Production Information			
Material	<input type="text"/>	Annealed <input type="checkbox"/>	Heat Treated <input type="checkbox"/>
Quantity	<input type="text"/>	Hardness <input type="text"/>	
Machine	Manual <input type="checkbox"/>	CNC <input type="checkbox"/>	Swiss <input type="checkbox"/> Other <input type="checkbox"/>
Toolholder Style	Left <input type="checkbox"/>	Right <input type="checkbox"/>	Toolholder Size <input type="text"/>

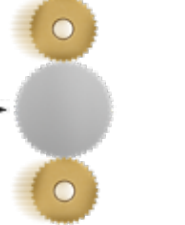
Knurling Tool Recommendation				
Customer Information	Figure	Dorian Tool Recommendation		
<input type="text"/>	<input type="text"/>	Item	UPC	Price
Date	<input type="text"/>	<input type="text"/>	<input type="text"/>	<input type="text"/>
Company	<input type="text"/>	Knurling Tool		
Contact	<input type="text"/>	Knurling Head		
E-mail	<input type="text"/>	Knurling Wheel		
Telephone	<input type="text"/>	Knurling Pin		













Knurling Application	Knurl Wheel Used			
<p>One Wheel In-feed (Plunge) End-feed</p>	<p>Straight</p> 	<p>Left Hand Diagonal</p> 	<p>Right Hand Diagonal</p> 	<p>Female Diamond</p> 
<p>In-feed (Plunge) with (1) wheel fixed knurling tool holder</p> 	<p>Straight Pattern</p> 	<p>Right Hand Diagonal Pattern</p> 	<p>Left Hand Diagonal Pattern</p> 	<p>Male Diamond Pattern (Raised Points)</p> 
<p>End-feed with (1) wheel fixed knurling tool holder</p> 	<p>Straight Pattern</p> 	<p>Right Hand Diagonal Pattern</p> 	<p>Left Hand Diagonal Pattern</p> 	



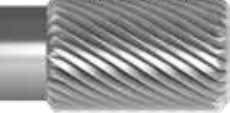

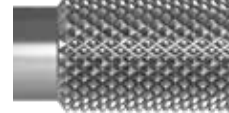
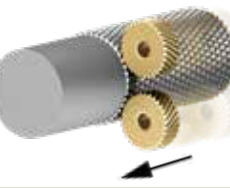

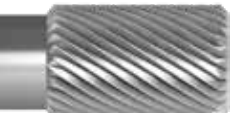

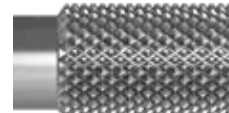
Knurling Application	Knurl Wheel Used					
<p>Two Wheels In-feed (Plunge)</p>	<p>Straight</p> 	<p>Left Hand Diagonal</p> 	<p>Right Hand Diagonal</p> 	<p>Male Diamond</p> <p>Right Hand</p> 	<p>Left Hand</p> 	
<p>In-feed (Plunge) with (2) wheels fixed knurling tool holder</p> 	<p>Straight Pattern</p> 	<p>Right Hand Diagonal Pattern</p> 	<p>Left Hand Diagonal Pattern</p> 	<p>Male Diamond Pattern (Raised Points)</p> 		
<p>In-feed (Plunge) with Adjustable Straddle Style knurling tool holder</p> 	<p>Straight Pattern</p> 	<p>Right Hand Diagonal Pattern</p> 	<p>Left Hand Diagonal Pattern</p> 	<p>Male Diamond Pattern (Raised Points)</p> 		

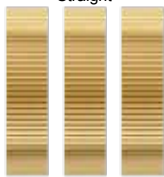
NOTE:
In-feed (Plunge): When the knurl wheel is pushed against the part into radial direction
End-feed: When the Knurl wheel moves longitudinal to the axis of the work piece

Knurling Application

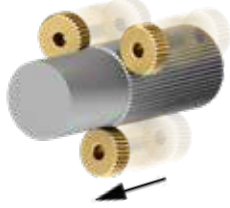
Knurl Wheel Used

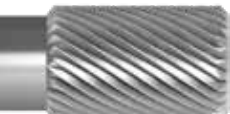

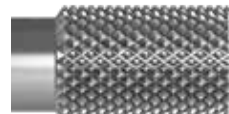
<p>Two Wheels End-feed</p>	<p>Straight</p> 	<p>Left Hand Diagonal</p> 	<p>Right Hand Diagonal</p> 	<p>Male Diamond Right Hand Left Hand</p> 
<p>End-feed (2) wheels with adjustable straddle knurling tool holder</p> 	<p>Straight Pattern</p> 	<p>Right Hand Diagonal Pattern</p> 	<p>Left Hand Diagonal Pattern</p> 	<p>Male Diamond Pattern (Raised Points)</p> 
<p>End-feed (2) wheels with adjustable fixed knurling tool holder</p> 	<p>Straight Pattern</p> 	<p>Right Hand Diagonal Pattern</p> 	<p>Left Hand Diagonal Pattern</p> 	<p>Male Diamond Pattern (Raised Points)</p> 

<p>Three Wheels End-feed</p>	<p>Straight</p> 	<p>Left Hand Diagonal</p> 	<p>Right Hand Diagonal</p> 	<p>Male Diamond Right Hand Left Hand</p> 
<p>End-feed (3) wheels with Adjustable Knurl holder cross slide</p> 	<p>Straight Pattern</p> 	<p>Right Hand Diagonal Pattern</p> 	<p>Left Hand Diagonal Pattern</p> 	<p>Male Diamond Pattern (Raised Points)</p> 

In-Feed

Male and Female Diamond knurl wheel pattern
Can be used only In-Feed

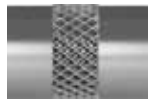
Max. knurl Diamond pattern on the workpiece is equal to the width of the knurl wheel

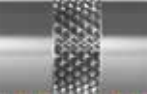
<p>Male</p>  <p>In-feed</p> 	<p>Female</p>  <p>In-feed</p> 
--	---

Tool Depth with Standard Circular Pitch Knurl		Circular Pitch	
Type of Knurl	Percentage of Depth of Knurl	inches	metric
Straight Tooth	35% of Circular Pitch (P)	1" TPI	Pitch size (mm)
Diagonal	35% of Normal Circular Pitch (Pn)		
Diamond	40% of Normal Circular Pitch (Pn)		
Diamond Female	25% of Normal Circular Pitch (Pn)		

Table 6 See page H-16

For Best Knurling Performance

Before beginning Knurling process check:

- Diameter before knurl
- Diameter after knurl
- Knurl pitch
- Workpiece to be concentric
- Set wheels on center line of workpiece
- Use beveled edge wheels when form knurling
- Use full faced wheels when cut knurling
- Always use coolant when knurling
- The standard knurling depth is 35% of knurl circular pitch.

Inch Example: Knurling Depth of 20 TPI Knurl

Circular Pitch of 20TPI is: $1.000/20 = .050"$
 Knurling Depth is: $.050" \times .035\% = .0175"$ per side

Metric Example: Knurling Depth of 2mm Knurl

Knurling Depth is: $2\text{mm} \times .035\% = .7\text{mm}$ per side

- If the knurl double tracks, the knurl wheel is not deep enough in to workpiece, increase knurling depth
- If the knurl crest rolls over, the knurl wheel is too deep in to the workpiece, decrease knurling depth
- If the knurl is not tracking, the workpiece diameter is not correct for full number of teeth, diameter must adjusted up or down by using a tracking formula.

In-Feed Knurling, when the knurl wheel enter into the workpiece radially. Once the knurl wheel has reached the depth, will take from **5 to 20** revolutions to complete the knurling operation. The revolution changes for the same size with the workpiece material hardness and knurl pitch.

End-Feed Knurling, when the knurl wheel enter into the workpiece axially. The depth of the knurl wheel must be set before the wheel get in contact with the workpiece, the depth and pressure changes for the same size with the workpiece material hardness and knurl pitch.

Forming Knurling Versus Cutting Knurl

- In Forming Knurl, the knurl wheel's axis is set parallel to the workpiece axis, and forced against workpiece displacing the material to form the knurl pattern
- A large amount of pressure is required to displace the material that forms the knurl pattern, and pressure increases with workpiece diameter, pitch size and hardness
- In a large workpiece diameter, large knurl pitch, and hard material, a multi knurling pass may be required to achieve the correct knurl pattern
- For best performance and quality in Forming Knurl, when possible, a Straddle Knurling Tool is to be used, the pressure is divided within the knurl wheels over the workpiece, and pressure against the spindle of the machine is totally neutralized.
- Use beveled edge wheel when knurl forming to protect the edge from chipping and for smooth knurling surface.
- Use full face Knurled wheel when knurl cutting, the knurl wheels axis are set on negative angle, the sharp edge will cut the knurl pattern into the workpiece
- In cutting knurl, less pressure is required for the operation, higher speed and feed can be used, (use the same cutting date of High Speed or Cobalt turning tools)
- Use full faced knurl wheel when knurl cutting.

Use Forming Knurl Tool for:

- Small to medium workpiece diameter
- To the shoulder knurling
- To centerless workpiece
- To band knurling application
- When high surface finish required

Use Cutting Knurl Tool for:

- Medium to large workpiece diameter
- To shoulderless diameter knurling
- To hard workpiece materials
- To long knurling application with live center
- For higher productivity

Knurling is ordinarily performed at the same speeds used as cutting operations. Use the same SFM used for high speed and cobalt tool bits to calculate speeds and feeds. However, where spindle speeds can be reduced without loss of production, it is recommended that spindle speeds be lowered as much as possible to increase knurl life.

Knurling Pitch Tracking Formula (See page H-12 for formula)

Step	Calculation	Inch
1	TPI	10
2	Diameter of the part after knurl	2.130"
3	Growth after Knurl based on pitch	.038"
4	Diameter of the blank before knurl	2.092"
5	Knurl wheel diameter and pattern (Straight)	.750"
6	Knurl wheel series	R
7	Knurl wheel tracking value	0.033"
8	Number of teeth on the workpiece	63.393
Correction		
9	Select the full number of teeth on the work piece	64
10	Knurl wheel tracking value	0.033"
11	New starting diameter = number of teeth x tracking value	2.112"

Knurling Pitch Tracking Formula

Step	Calculation	Metric
1	Circular pitch	2.5 mm
2	Diameter of the part after knurl	50.00 mm
3	Growth after knurl based on pitch	.97 mm
4	Diameter of the blank before knurl	49.03 mm
5	Knurl wheel diameter and pattern (Straight)	19.00 mm
6	Knurl wheel series	R
7	Knurl wheel tracking value (.033 X 25.4)	0.84 mm
8	Number of teeth on the workpiece	58.49
Correction		
9	Select the full number of teeth on the work piece	58
10	Knurl wheel tracking value	0.8382mm
11	New starting diameter = number of teeth x tracking value	48.615mm

Applications of knurling

Knurling has a wide variety of applications in day-to-day use. It is most commonly used for decorative purposes and for serrating surfaces where components are locked or keyed together in unit assemblies.

The term "knurling" designates both the process and the knurled portion of the work.

Knurling is obtained by displacement of the material when the knurl is pressed against the surface of a rotating work blank. A knurled tooth is "V" shaped.

Knurling tools are used for producing STRAIGHT, DIAGONAL or MALE and DIAMOND patterns, having teeth of uniform pitch on cylindrical sur-FEMALE, TAPER, ROUND and FLAT surface.

Knurling and Pitch Systems

The CIRCULAR PITCH SYSTEM knurling is related to the distance between the teeth on the circumference of the work blank inch or metric. In inches it usually expressed in terms of the number of teeth per inch (TPI), although sometimes erroneously referred to as Pitch.

The DIAMETRAL PITCH SYSTEM (inch system only) knurling is designed to permit work blank diameters of standard fractional stock sizes ranging from 3/32" - 1".

In-Feed Knurling (Plunge) (CNC -"X")

Straight or diamond knurling can be produced by using either one or two knurls mounted in a holder in the front or rear of the cross slide which applies direct pressure to the work.

Diamond knurls require greater pressure than straight or diagonal knurls, sometimes placing prohibitive loads on both machine and work, causing damage to the machine.

For a better knurling, Adjustable Floating Straddle Type Holders with two knurls are used. The two opposed knurls form the knurling as they are fed onto the blank. Side pressure on the work and the machine spindle is reduced with the straddle type holders, as most of the pressure required for knurling is absorbed in the holder.

End-Feed Knurling (To Chuck) (CNC -"Z")

Straight, diagonal, or diamond knurling may be produced with end-feed type knurling holders mounted on the compound or turret.

Knurls used for end-feed knurling should have beveled edges. Only straight and diagonal knurls can be used with the end-feeding holders.

When producing diagonal and diamond knurling, the straight knurls are swiveled in the holder to obtain the diagonal and diamond knurling as the knurls are fed over the blank.

Straight knurling may be produced with end-feeding holders using either straight or diagonal knurls.

End-feeding knurling method permits easier starting of the knurls with uniform raise up of material, resulting in high quality knurling.

Speed and Feeds

For in-feed knurling, the knurl should be fed toward the work gradually until contact is made with the blank. This can be completed within 5 to 25 work revolutions of the working piece.

For end-feed knurling, the feeds used with the turret vary considerably and are dependent on the pitch of the knurl, the material, the diameter of the work blank, and the hardness being knurled.

Two Ways to Achieve Knurling

(1) Forming

Knurl forming is achieved by pushing the knurl wheels against the blank while rotating. This will cause the material to be displaced in cold form, reproducing the same wheel pattern on the blank circumference.

The blank is increased accordingly to the Knurl Pitch. The force applied through forming is increased in larger diameters making knurling difficult and slow.



Use beveled edge wheel when knurl forming to protect the edge from chipping and for smooth knurl surface.

(2) Cutting

Knurl cutting is achieved by using knurl wheels to actually cut instead of forming the blank. The knurl wheels are set at an angle, making the knurling edges of the knurl wheels cut into the blank. Pressure is minimized while speed and feed are increased.



Use full face Knurled wheel when knurl cutting, the knurl wheels axis are set on negative angle, the sharp edge will cut the knurl pattern into the workpiece

For Best Knurling Results

1. Diameter of part being knurled should be turned to size and concentric to achieve a good knurling quality.
2. Knurl wheels must be exactly in center line with the work piece for an even knurl pattern.
3. Knurl wheels are to run freely and the knurl pin must be secured on the tool holder (the use of a carbide pin is recommended).
4. Use heavy flow of coolant to keep the knurl wheels cool and clean.
5. There are formulas to calculate depth of cut, tracking pitch and cutting parameter. Because of different material hardness, before starting production follow the instructions and with trial error the best result will be achieved.

When Ordering a Knurling Tool, Specify:

- | | |
|---------------------|--------------------------------|
| 1. Knurl pattern | 6. Qty. of parts being knurled |
| 2. Pitch style | 7. Tool center height |
| 3. Type of knurl | 8. Tool shank size |
| 4. Diameter range | 9. Right hand or Left hand |
| 5. Type of material | |

Knurling Tools Available:

1. Metric System
2. Inches System

Example: FKT20 = Metric System = 20 mm Shank

FKT75 = Inches System = 3/4 in Shank

Knurl Patterns

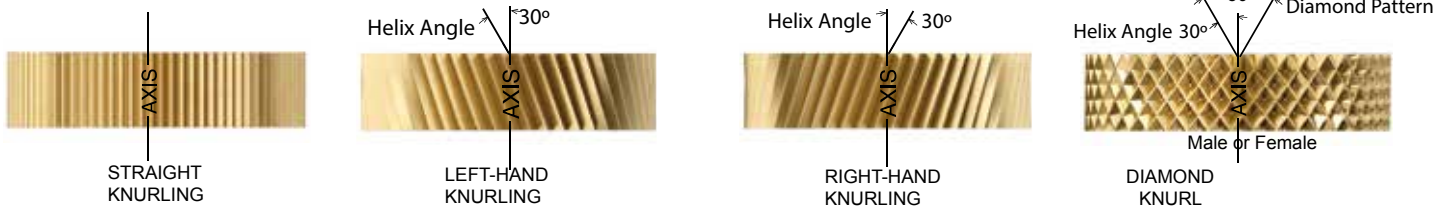

Tooth Form

A knurled tooth is V-shaped and the depth of the tooth is less than the depth of a theoretical V-form. The tooth has a rounded root and crest. The relationship between the actual depth of tooth to the theoretical V varies with the pitch of the teeth. On finer pitches, the tooth is a smaller proportion of the theoretical V-depth than coarser pitches. Also, female diamond patterns have shallower tooth depth than male diamond patterns.

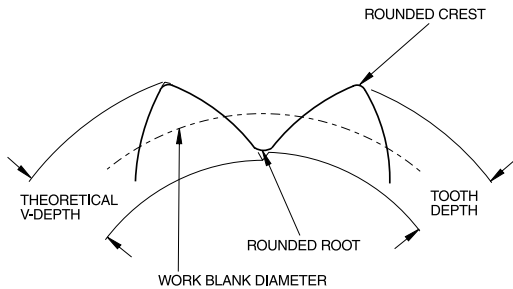

Straight Knurling

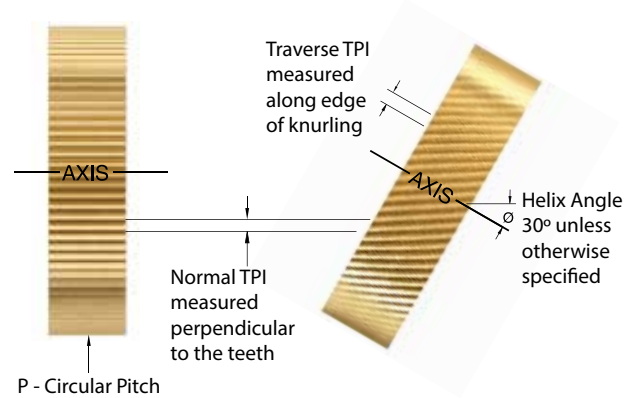

Diagonal or Diamond Knurling

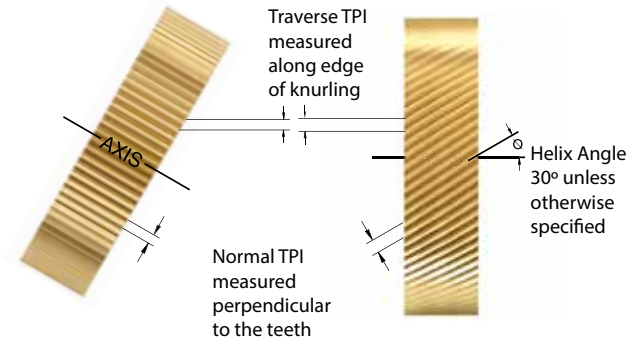

The Circular Pitch System

Circular pitch knurling is related to the distance between the teeth on the circumference of the work blank. It is usually expressed in terms as the number of teeth per inch, TPI, although sometimes erroneously referred to as pitch.

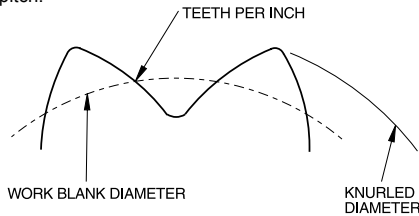

Number of Teeth per Inch - TPI

TPI refers to the number of teeth per inch measured on the circumference of the work blank diameter. The approximate TPI, however, may be measured on the outside diameter of the knurling for reference purposes. TPI is used and is measured perpendicular to the teeth or helix angle.

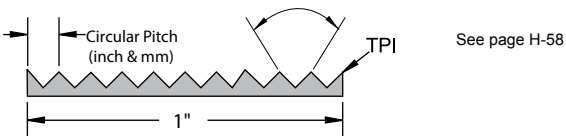

- **TPI system** is the number of teeth per inch (measured on a linear inch).
- **Circular pitch inch system** is the distance from tooth to tooth, or is derived from 1" divided by the number of teeth per inch.
- **Circular pitch metric system** is the distance from tooth to tooth in mm.
- **Diametral pitch system** is derived by the number of teeth on the work divided by the theoretical work blank diameter.

Table 1

Pitch Relation of a Straight Knurl to 30° Transverse

No. of Teeth per Inch TPI	Straight Knurling Circular Pitch		Transverse Circular Pitch		
	Inch	mm	TPI	Inch	mm
8	0.125	3.2	6.93	0.144	3.7
10	0.100	2.5	8.66	0.115	2.9
12	0.083	2.1	10.40	0.096	2.4
14	0.071	1.8	12.13	0.082	2.1
16	0.063	1.6	13.86	0.072	1.8
18	0.056	1.4	15.59	0.064	1.6
20	0.050	1.3	17.33	0.058	1.5
25	0.040	1.0	21.66	0.046	1.2
30	0.033	0.8	25.99	0.038	1.0
35	0.029	0.7	30.32	0.033	0.8
40	0.025	0.6	34.65	0.029	0.7
50	0.020	0.5	43.31	0.023	0.6
80	0.013	0.3	69.30	0.014	0.4

TPI and Circular Pitch Calculations

The formula for finding the Transverse Teeth Per Inch (TPI_t), if the Normal Teeth Per Inch (TPI_n) is known, is shown below.
 $TPI_t = TPI_n \times \cos 30^\circ$ (.86603)

The formula for finding the Transverse Circular Pitch (P_t), if the Circular Pitch (P) is known, is shown below.

$$P_t = \frac{P}{\cos 30^\circ}$$

$\cos 30^\circ = .86603$

TPI and Circular Pitch Examples

Find the Transverse Pitch if the Normal Pitch is 20 TPI.

$$TPI_t = TPI_n \times \cos 30^\circ = 20 \times .86603 = 17.32 \text{ TPI}_t$$

Find the Transverse Circular Pitch if the Normal Circular Pitch is .0500"

Where .0500" is the Normal Circular Pitch of 20 TPI ($1 \div .500 = 20$)

$$P_t = P_n \div \cos 30^\circ = .0500 \div .86603 = .0577 \text{ Circular Transverse Pitch}$$

Diagonal & Diamond Knurl Tooth & Pitch Calculations

$$TPI_t = \frac{N_w}{3.1416 \times D_w} \text{ or } TPI_n \times \cos \emptyset \quad TPI_n = \frac{N_w}{3.1416 \times D_w \times \cos \emptyset} \text{ or } \frac{TPI_t}{\cos \emptyset}$$

$$N_w = 3.1416 \times D_w \times TPI_t \text{ or } 3.1416 \times D_w \times TPI_n \times \cos \emptyset$$

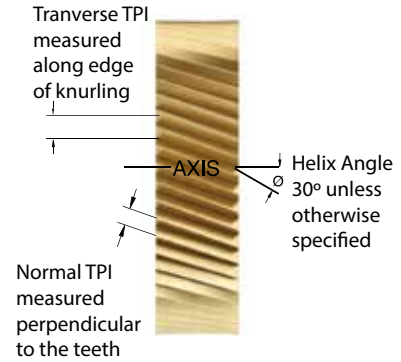

$$N_w = \frac{3.1416 \times D_w}{P_t} \text{ or } \frac{3.1416 \times D_w \times \cos \emptyset}{P_n} \quad D_w = \frac{P_t \times N}{3.1416} \text{ or } \frac{P_n \times N_w}{3.1416 \times \cos \emptyset}$$

Straight Knurl - Tooth and Pitch Calculations

$$P = \frac{1.000}{TPI} \quad N_w = \frac{3.1416 \times D_w}{P}$$

$$D_w = \frac{P \times N_w}{3.1416} \quad TPI = \frac{N_w}{3.1416 \times D_w}$$

Where:

- D_w** = Theoretical work blank diameter
- N_w** = Number of teeth on work
- P** = Circular pitch
- TPI** = Number of teeth per inch measured on circumference of blank diameter

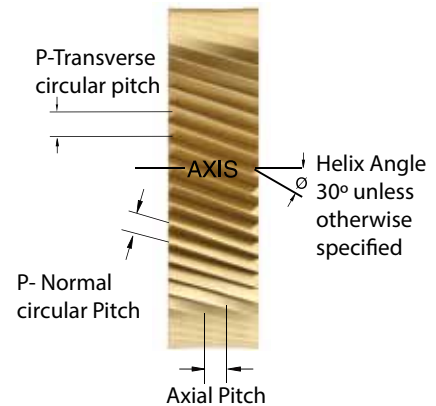
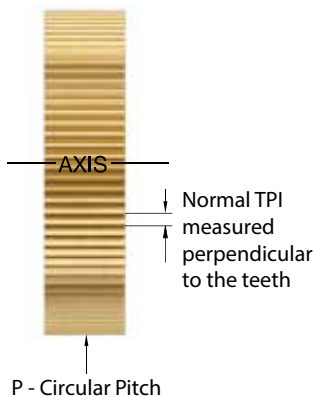

$$P = \frac{1.000}{TPI} \quad P_t = \frac{P_n}{.86603}$$

Where:

- D_w** = Theoretical work blank diameter
- N_w** = Number of teeth on work
- P** = Circular pitch
- P_n** = Normal circular pitch
- P_t** = Transverse circular pitch
- TPI** = Number of teeth per inch measured on circumference of blank diameter
- TPI_n** = Normal teeth per inch
- TPI_t** = Transverse teeth per inch
- ∅** = Helix angle

Standard Diametral Pitches

The four standard diametral pitches available are 64, 96, 128, and 160. The 96 and 160 diametral pitches are for blank diameters having fractional increments of 1/32", and the 64 and 128 diametral pitches are for blank diameters having fractional diameters of 1/64". The American Standard recommends that the use of the 64 diametral pitch should be avoided as much as possible, and for simplification of tools, preference be given to the use of 96 diametral pitch.

The term diametral pitch applies to the quotient of the total number of teeth in the circumference of the work divided by the basic diameter of the work blank. The diametral pitch is the ratio of the number of teeth on the work to the number of inches of basic work blank diameter and equals the number of teeth to each inch of basic blank diameter.

$$P = \frac{N_w}{D_w}$$

Where:

P=Diametral Pitch
 N_w =Number of teeth on work, or $P \times D_w$
 D_w =Theoretical work blank diameter or $\frac{N_w}{P}$

The diametral pitch and the number of teeth are always measured in a transverse plane which is perpendicular to the axis of rotation for diagonal as well as straight knurling.

A comparison of diametral pitches, TPI, and circular pitches is in Table 2.

Diagonal and diamond knurling on work blank may be accomplished by setting the axis of straight knurls at an angle to the work axis.

When using straight knurls to produce diagonal and diamond knurling by end-feeding, the transverse diametral pitch that is produced on the work will not be the same as that of the knurl. The diametral pitch in such instances refers to the diametral pitch on the knurl rather than the knurling produced on the work.

Table 2

Diametral Pitch-Increase of Blank Diameter													
Diametral Pitch Measured in TPI and Circular Pitch			Approx. Increase in Knurled Diameter				Min. No. of Teeth in Knurled Circumference	Work Blank Diameters					
Diametral Pitch	TPI	Circular Pitch	Straight		30° Diagonal			Diameter Range		Dia. Increments			
			Inch	mm	Inch	mm		Inch	mm				
64	20.4	0.0491	0.024	0.61	0.021	0.53	24	0.375	1.0	9.53	25.40	1/64"	0.41
96	30.6	0.0327	0.016	0.41	0.014	0.36	24	0.250	1.0	6.35	25.40	1/32"	0.36
128	40.7	0.0245	0.012	0.30	0.010	0.25	18	0.140	1.0	3.56	25.40	1/64"	0.41
160	50.9	0.0196	0.009	0.23	0.008	0.20	15	0.094	1.0	2.39	25.40	1/32"	0.79

Equivalent of Diametral Pitch & TPI Pitch

All Diametral Pitch Knurls made to American Standards (ASA B5.30 1958). Diametral Pitch Knurls produce the D.P. number of teeth per inch of diameter. Rolled Circular Pitch Knurls, produce the TPI number of teeth per inch of circumference measured normal to the teeth.

Table 3

Diametral Pitch	Teeth Per Inch (TPI)	
	Straight	30° Diagonal
64	20.4	23.6
96	30.6	35.3
128	40.7	47.0
160	50.9	58.8

Work Blank Diameters

Formulae for theoretical work blank diameters are as follows:

$$D_w = \frac{N_w}{P}$$

Where:
 P=Diametral Pitch
 N_w =Number of teeth on work, or $P \times D_w$
 D_w =Theoretical work blank diameter or $\frac{N_w}{P}$

For end-feed knurling with straight tooth knurls:

$$D_w = \frac{N_w}{P \times \cos \theta}$$

Where:
 P=Diametral Pitch
 N_w =Number of teeth on work, or $P \times D_w$
 D_w =Theoretical work blank diameter or $\frac{N_w}{P}$
 θ =Angle between knurl axis and work axis
 (cos 30°=.86603)

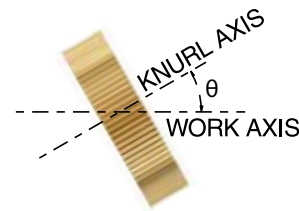

The number of teeth produced on the work blank is measured in the transverse plane and may be determined with the following formula for diagonal knurling.

Where:
 P = Diametral Pitch
 N_w = Number of teeth on work, or $P \times D_w$
 D_w = Theoretical work blank diameter or $\frac{N_w}{P}$
 θ = Angle between knurl axis and work axis

For Example:

If 30° diagonal knurling were to be produced on 1" stock with a 96 diametral pitch straight knurl.

$$N_w = 1.000 \times 96 \times \cos 30^\circ = 83.14 \text{ teeth}$$

(cos30° = 86603)

Increasing the angle between the knurl axis to approximately 30.25° would provide good tracking of the knurl and make it possible to obtain an even 83 teeth instead of 83.14.

By reducing the diameter of the work blank to a decimal size, good tracking of the knurl can be obtained for 30° diagonal knurling according to the following formula:

$$D_w = \frac{N_w}{P \times \cos 30^\circ} = \frac{83}{96 \times .86603} = .998 \text{ inch}$$

The tolerance for work blank diameters vary with the knurling requirements. For general purpose knurling the tolerances generally range between 5 to 8% of the circular pitch and for precise knurling, approximately 2 to 4% of the circular pitch.

Request for Diametral Blank Diameters X 50% larger

Knurled Diameters (Knurl Forming)

The approximate increase in blank diameters for different teeth per inch with straight, diagonal, and diamond pattern knurling is shown below. The amount of increase shown is based on knurling soft steels and should be used as a guide only. The amount of increase varies slightly with different materials. When the full depth of the knurl is not required (no sharp points), penetrate the work blank to displace at least 75% of the knurl tooth depth. This ensures proper tracking of the knurl on the work. Care should be exercised not to specify knurled diameters with too few teeth. Consideration should be also given to the length of the knurling and the pressure required to force the knurl into the work. The greatest pressures are exerted by the coarser pitches with in-feed knurling using single knurls. Wide knurls require more pressure than narrow knurls. The following tabulation may be used as a guide in selecting the smallest knurled diameters to use for knurling with different number of teeth per inch (TPI) and widths of knurl faces.

Table 4
Minimum Knurled Diameters
For In-feed Rolling with Circular Pitch Knurls on General Applications

Pitch	Standard Width of Knurl Face						
	3/16"		1/4"		3/8"		
TPI	mm	Inch	mm	Inch	mm	Inch	mm
16	1.6	-	-	0.406	10.3	0.500	12.7
20	1.2	0.313	7.9	0.344	8.7	0.438	11.1
25	1.0	0.250	6.4	0.281	7.1	0.375	9.5
30	0.8	0.219	5.6	0.250	6.4	0.313	7.9
35	0.7	0.188	4.8	0.219	5.6	0.281	7.1
40	0.6	0.156	4.0	0.188	4.8	0.250	6.4
50	0.5	0.125	3.2	0.156	4.0	0.219	5.6
80	0.3	0.078	2.0	0.109	2.8	0.172	4.4

Table 5
Approximate Diameter Increase of Blank
with Standard Circular Pitch Knurls

Pitch	Straight		Diagonal		Diamond on Part				
	Circular Pitch		Circular Pitch		Male		Female		
TPI	mm	Inch	mm	Inch	mm	Inch	mm	Inch	
8	3.2	0.042	1.1	0.042	1.1	0.046	1.2	-	-
10	2.5	0.038	1.0	0.038	1.0	0.042	1.1	-	-
12	2.1	0.034	0.9	0.034	0.9	0.038	1.0	0.023	0.6
16	1.6	0.025	0.6	0.025	0.6	0.029	0.7	0.017	0.4
20	1.2	0.020	0.5	0.020	0.5	0.023	0.6	0.014	0.4
25	1.0	0.016	0.4	0.016	0.4	0.018	0.5	0.011	0.3
30	0.8	0.013	0.3	0.013	0.3	0.015	0.4	0.009	0.2
35	0.7	0.011	0.3	0.011	0.3	0.013	0.3	0.007	0.2
40	0.6	0.009	0.2	0.009	0.2	0.010	0.3	0.006	0.2
50	0.5	0.009	0.2	0.009	0.2	0.010	0.3	0.006	0.2
80	0.3	0.005	0.1	0.005	0.1	0.006	0.2	0.004	0.1
TPI	mm	Diametral Pitch		Diametral Pitch		Male		Female	
64	0.4	0.024	0.6	0.021	0.5	0.024	0.6	0.015	0.4
96	0.3	0.016	0.4	0.014	0.4	0.016	0.4	0.010	0.3
128	0.2	0.012	0.3	0.010	0.3	0.012	0.3	0.007	0.2
160	0.1	0.009	0.2	0.008	0.2	0.009	0.2	0.005	0.1

Tooth Depth

Depth of tooth is in direct relationship with circular pitch knurl with approximate percentages which will vary, accordingly to material, speed, and feed used in knurling.

Table 6

Tool Depth with Standard Circular Pitch Knurl	Circular Pitch	
	inches	metric
Type of Knurl	Percentage of Depth of Knurl	
Straight Tooth	35% of Circular Pitch (P)	
Diagonal	35% of Normal Circular Pitch (Pn)	
Diamond	40% of Normal Circular Pitch (Pn)	
Diamond Female	25% of Normal Circular Pitch (Pn)	

Tooth Depth Examples

Inch Circular Pitch: find the circular pitch and depth of tooth for a straight tooth knurl and has 20 TPI.

$$P = \frac{1"}{20 \text{ TPI}} = .0500 \text{ Circular Pitch}$$

Metric Circular Pitch: The distance from tooth to tooth

$$P = 1 \text{mm Circular Pitch} \quad \text{Tool Depth} = 1 \times 35\% = .35$$

The resulting depth is per side. Multiply x2 for depth on diameter.

Tracking Calculations for Forming and Cutting knurl.

Follow the **steps 1-10** below to prepare the proper diameter to turn your diameter before knurling in order to improve the success of knurling without double tracking.

Step 1: Diameter of the part after knurl: _____
(skip to step 3 if the diameter before knurl is only diameter specified)

Step 2: Growth of material after knurling based on TPI: _____
(see Table 5)

Step 3: Diameter before knurl _____
(step 1 - step 2, or use diameter given on print if starting here at this step)

Step 4: Quick calculator value: _____
(see knurl wheel pages for your exact wheel. Example: shown below **.0330**)
PAGES H-60 to H-70

Step 5: Calculate number of teeth on part after knurl: _____
(diameter of part before knurl from step 3 / quick calculator value, example: 1.138 dia / .033 = 34.5 teeth on part after knurl)

Step 6: Evaluate value in step 5
(fractional values can lead to double tracking. In the above example, there will be 34 teeth on the part with .5 of a tooth left over. This 1/2 tooth overtravel will most likely double track. To solve this continue to step 7)

Step 7: Round to closest whole number _____
(in the above example either 34 or 35 can be used)

Step 8: Calculate new diameter to turn material before knurl: _____
(quick calculator value x rounded number of teeth from step 7, example: .033 x 34 = 1.122 diameter of the part before knurl to track properly)

Step 9: Calculate diameter after knurl based on new tracking diameter: _____
(add growth value from step 2 to new tracking diameter from step 8)

Step 10: Verify against print tolerances

Example for Step 4:

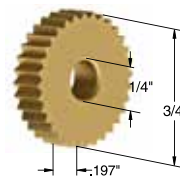

Circular Knurl Pitch		Included Tooth Angle	Knurl Pattern	R Series	Straight
Inch	Metric			Knurl Wheel	Cobalt TiN Coated
10 (TPI)	2,5mm	90°	Coarse	Description	RS-10-C
				Tracking Data	23T / .0330"
				Standard	26502

Traditional Formula for Step 5:

Table 7

Correction Factor		
TPI	Approx. Value of C.F.	
	Inch	mm
12-19	0.010	0.3
20-29	0.007	0.2
30-39	0.005	0.1
40-49	0.003	0.1
50-80	0.002	0.05

** This value is affected somewhat by machine speeds, material hardness, relative diameters of knurl and blank.

$$\text{Teeth (on blank)} = \frac{\text{Teeth (on knurl tool)} \times \text{Diameter (Blank)}}{\text{Diameter (wheel)} + \text{Correction Factor}}$$

* Note: These formulas apply accurately only to knurls In-Fed from the cross-slide.

Cutting Speed

Knurling is ordinarily performed at the same speeds used as turning operations. To calculate the cutting parameter of a knurling operation, use the same SFM used for high speed and cobalt tool bits to calculate (RPM) revolution of the workpiece and Knurling (f_n) feed rate.

For in-feed knurling, the knurl should be fed toward the work gradually until contact is made with the blank. As few work revolutions as possible should be allowed for feeding the knurl into the work. The knurl should be fed to full depth as rapidly as permissible without causing undue pressure on the work, the tools, and the equipment. Too many revolutions may result in a roughened or slivered tooth surface and destruction of the knurl and the knurling tool (5 to 20 REV)

For end-feed knurling, the rate of feed is governed by the type of material being knurled, diameter and rigidity of the work, and the width and pitch of the knurl. Faster feeds are used for the softer materials and slower feeds for harder materials.

Knurling Formula:

$$RPM = \frac{12 \times SFM}{\pi \times DIA} \quad SFM = \frac{(DIA \times \pi) \times RPM}{12}$$

Although the knurling should be normally completed within 10 to 25 work revolutions, the ability of many machine cross slides to operate at the desired high speeds prohibits the use of the preferred revolutions, especially when high work spindle speeds are used.

The cam rise must be continuous with no dwell or backing away until the high point is reached. It is desirable to have a slight dwell on the cam at the completion of the feeding which allows several revolutions of the work with the knurl at full tooth depth. The amount of dwell depends upon the nature of the work and the material. The knurl should be then withdrawn from the work quickly.

The feeds used for end-feed knurling with the turret vary considerably and are dependent upon the pitch of the knurl, material being knurled, and the nature and diameter of the work.

-Warning- Speeds and feeds information in the catalog are for reference only. If the operator does not feel safe using our speeds and feed recommendation, the operator should use what he or she is comfortable with. Dorian Tool is not responsible for any injuries that may occur.

Knurling SFM and V_c parameter

Table 8

Material and Knurl Pitch				Knurl Forming			Knurl Cutting		
Material Description	Material Specs	TPI	Metric Pitch	Forming Speed (SFM and V_c)		Feed rate (f_n)		Cutting Speed	End Feed
				Smaller <Wheel dia. >Larger		End Feed	In Feed		
Low carbon steel	1018 1117 1215	>14	>1,8	50-210 SFM [15-63 V_c m/min]		0.006"	.001-.003"	100-350 SFM [30-106 m/min]	0.009"
		16-20	1,6-1,2			[0,15mm]	[,025-.075mm]		0.011"
		25-35	1,0-0,7			[0,20mm]	[0,050-.100mm]		0.013"
		40>	0,6>			[,25mm]	[,050-.100mm]		0.015"
Alloy Steel Tool steels	4130 4140 D2	>14	>1,8	35-150 SFM [10-45 m/min]		0.004"	.001-.002"	70-250 SFM [21-75 m/min]	0.007"
		16-20	1,6-1,2			[,10mm]	[,025-.050mm]		0.008"
		25-35	1,0-0,7			[,13mm]	[,025-.075mm]		0.010"
		40>	0,6>			[,18mm]	[,025-.075mm]		0.012"
Stainless Steel	304 17-4	>14	>1,8	35-150 SFM [10-45 m/min]		0.004"	.001-.002"	70-250 SFM [21-75 m/min]	0.007"
		16-20	1,6-1,2			[,10mm]	[,025-.050mm]		0.008"
		25-35	1,0-0,7			[,13mm]	[,025-.075mm]		0.010"
		40>	0,6>			[,18mm]	[,025-.075mm]		0.012"
Aluminum Brass Plastic	6061 C360 Delrin	>14	>1,8	90-390 SFM [27-118 m/min]		0.008"	.002-.004"	110-420 SFM [33-127 m/min]	0.011"
		16-20	1,6-1,2			[,20mm]	[,050-.100mm]		0.013"
		25-35	1,0-0,7			[,25mm]	[,075-.125mm]		0.016"
		40>	0,6>			[,33mm]	[,075-.125mm]		0.020"

Note: When knurling, start with low Cutting speed, to evaluate the wheel performance, (to avoid the premature life of the wheel) increase until optimum cutting speed and feed is achieved

Dimensioning of Diametral and Circular Pitch Knurling

Uniform drafting practice is desirable and dimensioning should include length and knurled diameter of the knurling and specifications of the teeth. The method for dimensioning diameters and tooth specifications is important as improper use of dimensions may result in considerable confusion.

Always specify the **tooth pattern** of the knurling, stating whether it is **straight, diagonal, or diamond** (male or female) **pattern**. Note whether the diagonal knurling is **right** or **left** hand, and indicate the **helix angle**.

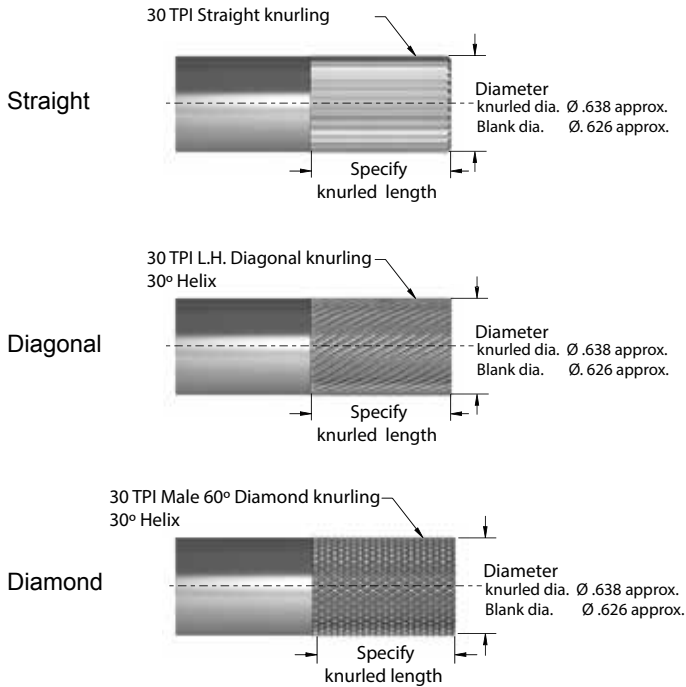

General Purpose Knurling

For general purpose knurling, only limited dimensions are necessary.

- TPI (Teeth Per Inch) or Coarse / Medium / Fine
- Work Blank Diameter
- Knurled Diameter

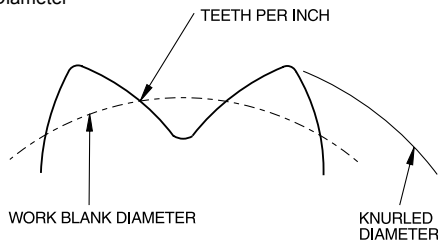

Precision Knurling

Knurled diameters and the circular pitch of the knurl are related. The circumference of the work blank should be an approximate multiple of the circular pitch for straight knurling and transverse circular pitch for diagonal and diamond knurling. Blank diameters vary with the circular pitch of the knurling selected, and should only be specified after the proper diameter of blank is determined by trial and error.

Knurling head center line adjustment



- Knurl tool is too low from center line.
- Top wheel is cutting a deeper R.H. Diagonal Knurl.
- Adjust center height until both wheels are on center and touching simultaneously.



- Knurl tool is too high from center line.
- Bottom wheel is cutting a deeper L.H. Diagonal Knurl.
- Adjust center height until both wheels are on center and touching simultaneously.



- Tool is on center line.
- Both wheels are touching simultaneously, forming a perfect diamond knurl.

Note: For a symmetric and even knurl pattern on the workpiece, the knurl wheels must be set on centerline of the workpiece. Both wheels must touch simultaneously

Common Knurling Problems

Common Knurling Problems		
Problem	Cause	Solution
Knurling double tracking	<ol style="list-style-type: none"> 1) Knurl wheel not deep enough into the workpiece 2) The circumference of the workpiece blank is a not full multiple of the knurl pitch 	<ol style="list-style-type: none"> 1) Increase the depth of the knurl wheel into the workpiece 2) Change the blank diameter +/- .005" (.127mm) or use the tracking formula
Knurling flaking or slivered	<ol style="list-style-type: none"> 1) Knurling a workpiece material with scaling or rough surface 2) Over-rolling the knurl wheel into the workpiece when in-feed knurling 3) Knurl Wheel too deep into the workpiece when end-feeding 4) Using 1:1 knurl to workpiece ratio 	<ol style="list-style-type: none"> 1) Turn the scaling or the rough surface of workpiece into a smooth surface 2) When in-feed knurling, reduce the depth of the knurl wheel, or reduce the number of revolutions after the knurl wheel has reached knurling depth 3) When end-feeding, reduce the depth of the knurl wheel 4) Use larger or smaller diameter wheel
Knurl destruction	<ol style="list-style-type: none"> 1) Knurling a workpiece material with scaling or rough surface 2) Over-rolling the knurl wheel into the workpiece when in-feed knurling 3) Knurl Wheel too deep into the workpiece 4) Use of sharp full faced knurl wheel when knurl forming 	<ol style="list-style-type: none"> 1) Reduce the depth of the knurl wheel 2) Reduce the number of revolutions after the knurl wheel has reached knurling depth 3) Reduce feed and speed and improve coolant flow 4) Use beveled edge when form knurling
Knurl wheel poor life	<ol style="list-style-type: none"> 1) Knurling a workpiece material with scaling or rough surface 2) Over-rolling the knurl wheel into the workpiece when in-feed knurling 3) Knurl Wheel too deep into the workpiece when end-feeding 4) Workpiece material too hard, or difficult to knurl (stainless steels and high temp alloys) 5) Workpiece not running concentric 6) Workpiece too hard 7) Knurl wheel not properly hardened 8) Poor lubrication 9) Not using the correct knurl wheel for the application 10) Knurl wheel not beveled 	<ol style="list-style-type: none"> 1) Turn the scaling or the rough surface of workpiece into a smooth surface 2) When in-feed knurling, reduce the depth of the knurl wheel, or reduce the number of revolutions after the knurl wheel has reached knurling depth 3) When end-feeding, reduce the depth of the knurl wheel 4) Reduce feed and speed and improve coolant flow 5) Turn workpiece concentric and into a smooth surface 6) Reduce workpiece speed 7) Change the knurl wheel 8) Improve coolant flow 9) Use beveled knurl wheel(s) when forming knurling; use full faced knurl wheel(s) for cutting knurling 10) Use a beveled knurl wheel
Uneven depth of knurl	<ol style="list-style-type: none"> 1) Knurling a workpiece material with scaling or rough surface 2) Workpiece not running concentric 3) Using 1:1 knurl to workpiece ratio 	<ol style="list-style-type: none"> 1) Turn the scaling or the rough surface of workpiece into a smooth surface 2) Turn workpiece concentric and into a smooth surface 3) Use larger or smaller diameter wheel
Twisted knurl pattern	<ol style="list-style-type: none"> 1) Knurl wheel not deep enough into the workpiece 2) The circumference of the workpiece blank is not a full multiple of the knurl pitch 	<ol style="list-style-type: none"> 1) Increase the depth of the knurl wheel 2) Change the blank diameter +/- .005" (.127mm) or use the tracking formula
Uneven Knurl Pattern	<ol style="list-style-type: none"> 1) Knurl wheels are not in centerline of the workpiece 	<ol style="list-style-type: none"> 1) For a symmetric and even knurl pattern on the workpiece, the knurl wheels must to be set on centerline properly

Wheel and Pin Care For Shoulder Type Form Tools



To replace or check knurl wheel and pin check the following:

1. Removal of Knurl Pin

After all the holding screws are removed, sometimes the pin is still tight in the holder. These can be removed by slightly tapping them out with a proper punch.

2. Inspection

Inspect the wheel and pin for burrs or other characteristics which may inhibit proper function of the wheel and pin.

3. Lubrication

Use plenty of high temperature grease between knurl and pin.

4. Wheel and Pin Engagement

The pin should be tightened until the knurl wheel is free of play yet can spin freely by hand.

Wheel and Pin Care For Shoulderless Type Form Tools



To replace or check knurl wheel and pin check the following:

1. Removal of Knurl Pin

After all the holding screws are removed, sometimes the pin is still tight in the holder. These can be removed by slightly tapping them out with a proper punch.

2. Inspection

Inspect the wheel and pin for burrs or other characteristics which may inhibit proper function of the wheel and pin.

3. Lubrication

Use plenty of high temperature grease between knurl and pin.

4. Wheel and Pin Engagement

Tighten the holding screws to hold the pin secure with the wheel placed inside the holder.

For single wheel knurling tool

1. Mounting instructions:

Clamp the shank at right angles to the axial center line of the machine.



2. Center Height: Center height is not as critical on a single wheel tool as the wheel contact at all positions. Although too much difference may make it harder to judge depth engagement when feeding into the part.

3. Knurling setup: With the spindle rotating slowly, in-feed (Plunge) the tool slowly until the wheel starts to move. Set this position as your zero point.

4. Starting the knurl: Start the machine and position the knurl. If the knurl is starting on the end of the part, position the wheel 1/8" on the end. Then, in-feed (Plunge) to the full depth calculated using the formulas on the previous pages.

If knurling a straight pattern the tool can then be fed longitudinally (end feed) with automatic feed. If knurling a diamond pattern, this type of tool is plunge only (in feed); longitudinal (end feed) is not recommended. See page H-16 for approximate feed rates.

Important: Always use a steady flow of coolant to keep the wheel cool and free of chips.

For double wheel fixed knurler

1. Mounting instructions:

Clamp the shank at right angles to the axial center line of the machine.



2. Center Height: Center height is critical on a double wheel tool as the eye can see even the smallest variance when producing a cosmetic knurl. This style of tool is recommended for machines that have a means to adjust center height. It may be used on a CNC, but will be cumbersome during setup to shim to center.

3. Knurling setup: With the spindle rotating slowly, in-feed (Plunge) the tool slowly until both wheels starts to move at the same time. Set this position as your zero point.

4. Starting the knurl: Start the machine and position the knurl. If the knurl is starting on the end of the part, position the wheel 1/8" on the end. Then, in-feed (Plunge) to the full depth calculated using the formulas on the previous pages. The tool can then be fed longitudinally (end-feed) with automatic feed. See page H-16 for approximate feed rates.

Important. Always use a steady flow of coolant to keep the wheels cool and free of chips.

Beveled versus Full Faced

When knurling longitudinally (end-feed) beveled edge knurl wheels should be used during form knurling, allowing the knurling wheel to gradually form the knurled part without chipping the edge of the wheel, and create a cleaner and smoother knurled pattern.

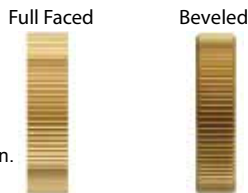

When plunge knurling (In Feed) a beveled or full faced knurl wheel may be used according to the required width.

Use full faces wheels for cutting knurling applications.

Edge Prep

For double wheel self-centering knurling tool

1. Mounting instructions:

Clamp the shank at right angles to the axial center line of the machine.



2. Center Height: Center height is critical on a double wheel tool as the eye can see even the smallest variance when producing a cosmetic knurl. This style of tool is recommended for most machines because of its easy set up. There is no need to adjust center height.

3. Knurling setup: With the spindle rotating slowly, in-feed (Plunge) the tool slowly until the top wheel touches. The top wheel will always touch because of gravity. Continue feeding until the head pivots and the bottom wheel starts to move. Set this position as your zero point.

4. Starting the knurl: Start the machine and position the knurl. If the knurl is starting on the end of the part, position the wheel 1/8" on the end. Then, in-feed (Plunge) to the full depth calculated using the formulas on the previous pages. The tool can then be fed longitudinally (end-feed) with automatic feed. See the Speed and Feed for approximate feed rates.

Important: Always use a steady flow of coolant to keep the wheel cool and free of chips.

For Straddle Style Knurl Tools

1. Mounting instructions: Clamp the shank at right angle to the axial center line of the machine.



2. Center Height: Dorian straddle style tools have some floatation to allow centering during setup.

3. Knurling setup: Dorian straddle knurling tools are adjusted using one screw that moves both arms. The screw is slightly shorter than the body to allow some floating. Knurling is performed with the set screws locked to hold the arms rigid.

The tool is adjusted and set up as follows:

- Loosen locking screws on the side of the holder.
- Use a hex wrench to turn screw to open the arms larger than the part.
- Calculate the diameter required for the depth of the knurls using the formulas provided earlier in the text.
- Place a piece of raw material into the chuck and turn it to the diameter determined above.
- Jog the tool to place the wheels above and below the part on centerline.
- Turn the adjustment screw until both wheels touch the material.
- Lock the locking screws over the arms only. Tightening the other screws will bend the protective shim.
- The tool is now set on center and at depth to knurl the actual part.

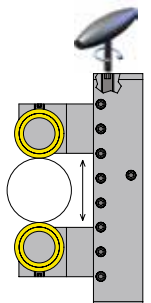

4. Starting the knurl: Start the machine and position the knurl. If the knurl is starting on the end of the part, position the wheel 1/8" on the end. Then, in-feed (Plunge) to the centerline of the part. The tool can then be fed longitudinally (end-feed) with automatic feed. See page H-16 for approximate feed rates.

Important: Always use a steady flow of coolant to keep the wheel cool and free of chips.

Knurling on conical, concave, convex, or radial surface

Often, parts require knurling on conical, concave, convex, or radial surfaces, either for functional or decorative purposes. With proper tools and application, a clean, well-formed knurl or serrations can be produced.

One of the most frequent mistakes made is illustrated in **Figure 1**. In this case, usually for convenience, the knurling tool and the part are set with parallel axis. This is similar to running a pair of bevel gears the wrong way. As the cone angle increases, the results become worse.

Figure 2 while technically not correct, is better than **Figure 1**, and has the advantage of being a substantially lower cost tool. This method is satisfactory on relatively large diameters when the cone angle is small.

Figure 3 illustrates the proper method of rolling conical surfaces to produce a clean knurl with maximum tool life. With proper designed tools, and using this method, it is possible to roll tapered serrations with a controlled number of teeth.

For proper tracking at both ends of the piece, it is necessary to establish the geometrical relationship between the part and the tool with consideration given to the space available for tooling. It is sometimes advantageous to use a shank-type knurl, as shown in **Figure 4** where clearance is not available for the conventional style knurl holder.

In certain cases, parts may be knurled with radial teeth on the end of parts, by using a conical knurl of the proper design. Here again, the results depend primarily on establishing the geometrical relationship between the part and the tool (**See Figure 5**).

A tracking correction factor is usually applied to the calculated diameter because of the many variables involved, such as hardness of material, elasticity of machine tools and tool holders, etc. This factor is necessarily empirical.

It is geometrically impossible to knurl a perfect concave or convex part with conventional knurls. The problem is illustrated in **Figure 6**. If the pitch on the tool or part changes by more than 25% from the middle to the edges, poor results can be expected on the finished part. A change of less than 10% in the pitch should produce a clean looking part.

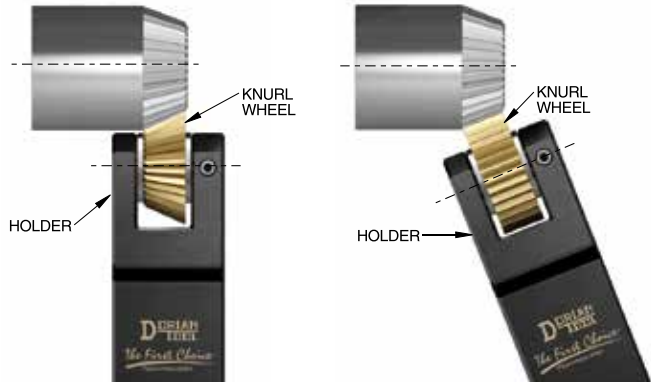

Figure 1 - Not good

Figure 2 - Better

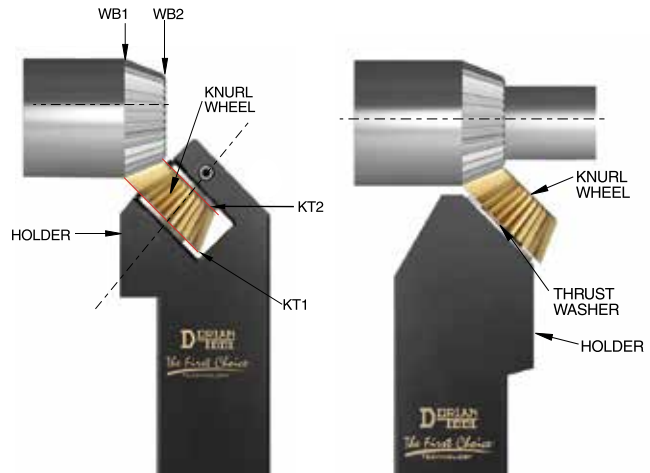

Figure 3 - Best

Figure 4 - Shank-Type Knurl

SEE FIGURE 3

$$\frac{WB1}{*KT1} = \frac{WB2}{*KT2}$$

* Correction Factor Less Tracking

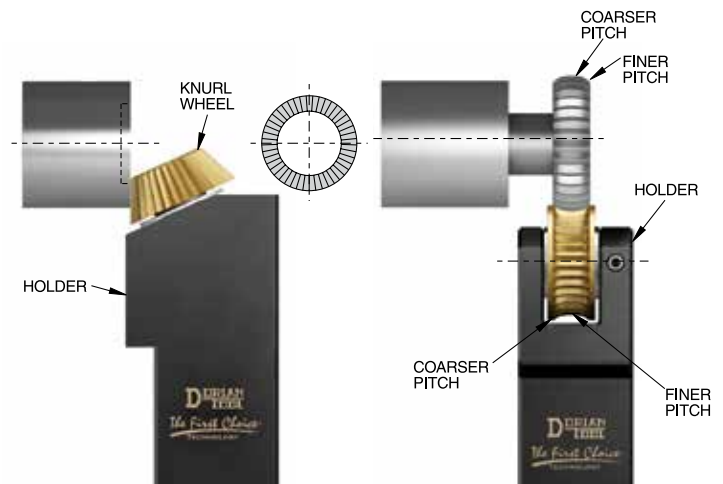
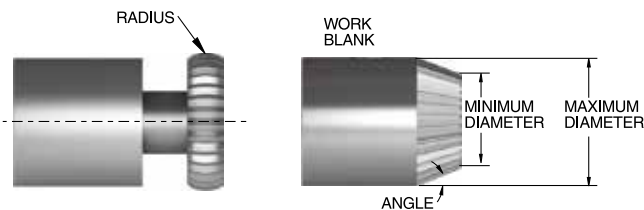
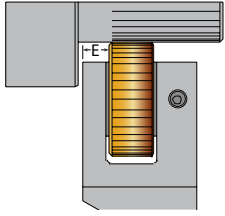

Figure 5 - End Knurling

Figure 6 - Convex Knurling

E = Shoulder Clearance



The minimal distance to a shoulder that the knurl tool can approach.

T = Shank Width

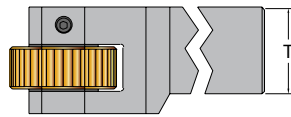

The width of the shank. This can be square or rectangular.

T1 = Head width

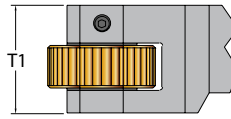

The width of the head can help to determine placement of the tool on the part.

S = Shank Height

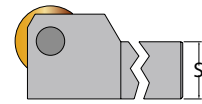

The height of the shank. This is determined by the requirement of the lathe.

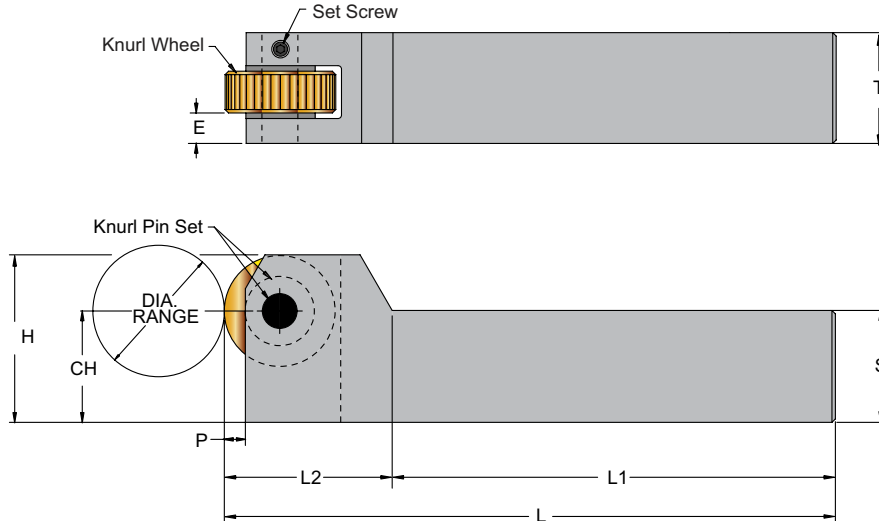

H = Head Height

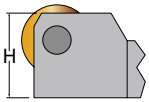

The height of the head. This is used to determine if there may be a tool clearance issue on a CNC lathe turret.

CH = Center Height

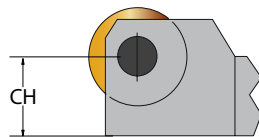

Dimension required to position centerline of tool with the chuck of the lathe.

Dia. Range

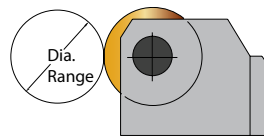

The minimum and maximum diameters suggested to effectively use the knurl tool to produce a good knurl. See individual notes on specifications.

P = Wheel Projection

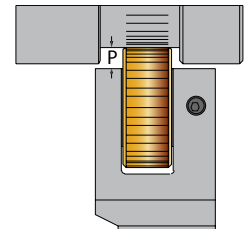

The distance that the wheel protrudes from the holder. This is generally useful when needing to knurl inside a slot or over a shoulder.

L = Length

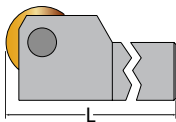

Overall length of tool.

L1 = Length of Shank

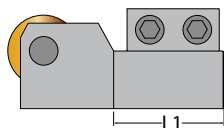

The amount of shank that can be held in the holding mechanism of the turret or tool post.

L2 = Length of Head

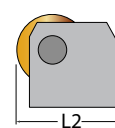

The amount of the tool that protrudes from the holding mechanism. This is relevant for indexing clearance on CNC turrets.

CNC Modular Knurling Tools

With the Flexibility of Multiple Knurling Applications!

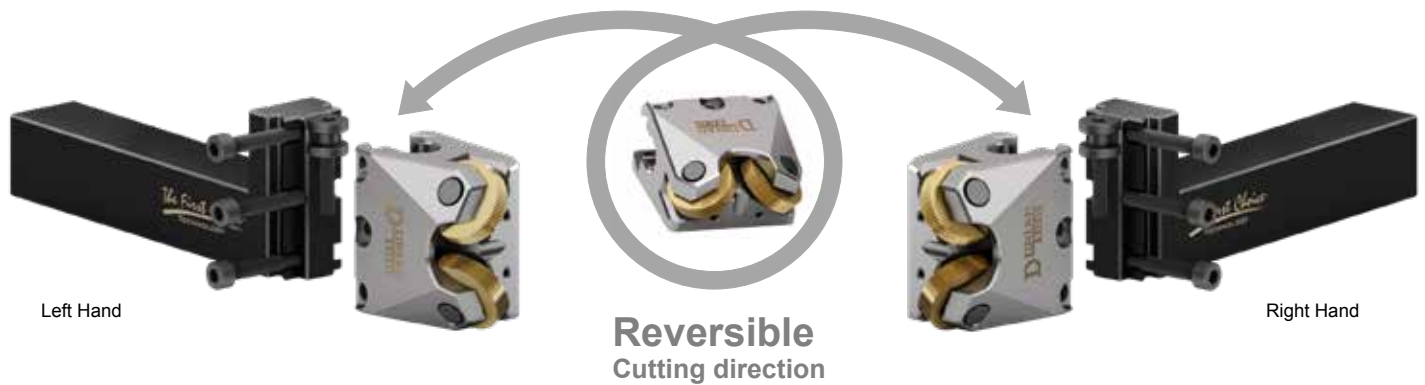

Versatility

- **Multi diameter** diamond knurling cutting style
- **Reversible** Head for Right or Left knurling.
- **Heavy duty** knurl cutting and knurl forming
- **Double Wheel** forming knurling head
- **Straddle** forming knurling head
- **Shoulder** forming knurling head
- **Wide diameter** range for small diameter to large diameter parts



Modular

Multi shank size interchangeable with 8 knurling heads.

Adjustable

Dovetail knurling head locking system.
Quick and precise center line setting.
Knurling wheel angle stationary for diamond cutting

Two Ways to Knurl

Forming (five heads available)

Knurl forming action (material displacement by means of rolling) is generally for special application. It creates a better quality of knurl pattern, but speeds and feeds are sacrificed for this quality. The force applied through forming is increased in larger diameters making knurling difficult and slow.

Cutting (three heads available)

Knurl cutting action cuts a perfect knurl pattern 10 to 20 times faster than any conventional knurling tool. It is engineered to knurl any material, including thin wall tubing, with minimum stress to the spindle and work piece. Knurl cutting action speeds up knurling enough to become applicable for CNC use.

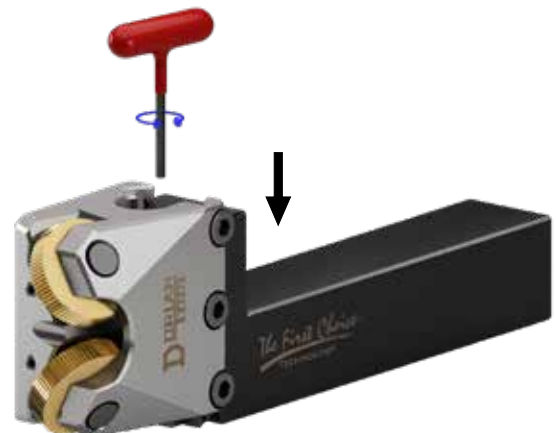

CNC-100-3-M used for examples.

Knurling Tools Cutting Operation

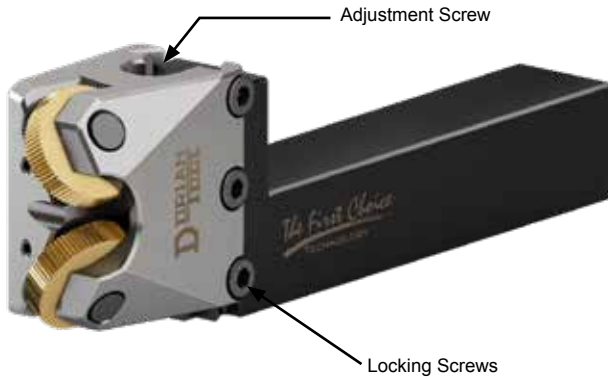

Mounting to the Machine

Clamp the shank at right angles to the axial center line of the machine. The knurl wheels of the knurling tool head should be set exactly on center.

To adjust center-height:

1. Loosen the lock screws.
2. Turning the adjustment screw adjusts the head up or down.
3. Turn adjustment screw until the center height is aligned.
4. Lock head back in place by tightening the lock screws.

Knurling Adjustment Set Up

With the machine spindle rotating slowly, in-feed (Plunge) the tool to make a slight impression for the full width of the cutter. This impression should be equal on both wheels when using Diamond Knurling Head. Misaligned patterns can be corrected by turning the fine adjustment screw in opposite directions.

Starting Cutting Knurl



- 1) Touch the workpiece diameter with the knurl wheels.

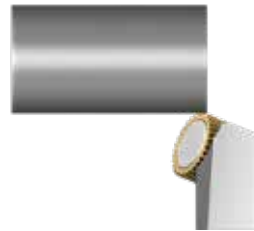







- 2) Move the knurling wheel to the end of the workpiece
 - Set the cutting depth of the wheel (35% of the circular pitch)
 - Start knurl

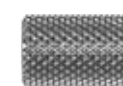

- 3) Use recommended cutting parameter
 - Use coolant

Knurling head center line adjustments

 R.H. Spiral		<ul style="list-style-type: none"> • Knurling tool is too low from center line. • Top wheel is cutting a deeper R.H. Diagonal Knurl. • Turn the Fine Center Adjustment Screw until both wheels are on center and touching simultaneously.
 L.H. Spiral		<ul style="list-style-type: none"> • Knurling tool is too high from center line. • Bottom wheel is cutting a deeper L.H. Diagonal Knurl. • Turn Fine Center Adjustment Screw until both wheels are on center and touching simultaneously.
 Diamond Knurl		<ul style="list-style-type: none"> • Tool is on center line. • Both wheels are touching simultaneously, cutting a perfect diamond knurl.

Full Faced Cutting Knurl Wheel

When cut knurling, a full faced knurl wheel must be used. The edge of the knurl wheel will be cut into the material to be knurled. A sharp edge must be kept to cut a clean and smooth knurl pattern. The knurl wheel can be reground once the edge is dull or chipped.

Edge Prep

Full Faced



Wheel Grinding

When the cutting edges of the knurl wheel become dull, re-sharpen them by grinding the cutting face of both wheels evenly. You can also grind forming wheels to desired width, but bevel afterwards.

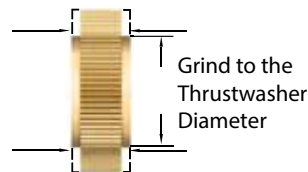

R & M SERIES KNURL WHEEL

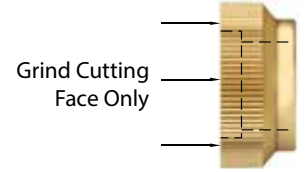

SW SERIES KNURL WHEEL

Easy to set up Simple to operate.

To minimize set up time of knurling application, and simplify the knurling operation, the CNC Modular Knurling Tool has been engineered to create a diamond knurling pattern, without the need of resetting the knurl wheels every time the workpiece diameter changes.

To cover the full range of diameter three modular cutting knurling head have been developed.

- 1) Small diameter modular head
- 2) Medium diameter modular head
- 3) Large diameter modular head

Small Diameter Head



Cutting Range

Small Diameter Cutting Range 1/2" to 1-1/2" (12mm to 38mm)

End feed range: .004" to .012"

- Knurl cutting action
- Twin straight SW series knurl wheels for male diamond pattern
- Supplied with Full Faced SW2S-30-HS knurl wheels - TiN coated

Medium Diameter



Medium Diameter Cutting Range 1" to 5" (25mm to 127mm)

End feed range: .004" to .016"

- Knurl cutting action
- Two straight R series knurl wheels for male diamond pattern
- Supplied with Full Faced RS-25-HS knurl wheels - TiN coated

Large Diameter



Large Diameter Cutting Range 2" & up (50mm & up)

End feed range: .004" to .025"

- Knurl cutting action
- Two straight M series knurl wheels for male diamond pattern
- Supplied with Full Faced MS-25-HS knurl wheels - TiN coated

How the diamond CNC Modular Knurling tool works.

- 1) Choose the cutting diameter range of the knurl head
- 2) Set the knurling wheel on centerline of the workpiece
- 3) Touch the workpiece diameter with the knurl wheels.
- 4) Set the depth of cut (35% of the circle pitch)
- 6) Start to cut recommended cutting parameter

- Flexibility
- Multiple combinations
- Multiple applications
- Better performance

**Six
Modular Shank Sizes**

**Eight
Modular Heads**

- Designed for the CNC Lathe
- Precision square shank with preset center height
- Right or Left hand applications
- Interchangeable shanks & heads
- High Speed knurl wheels (TiN coated)
- Supplied with heavy duty parts

1 Light Duty 60° Diamond Cutting Modular Knurling Head - CNCKH-1-2



Cutting

Small Diameter Cutting Range 1/2" to 1-1/2" (8mm to 38mm)

End feed range: .004" to .012"

- Knurl cutting action
- Twin straight SW series knurl wheels for male diamond pattern
- Supplied with Full Faced SW2S-30-HS knurl wheels - TiN coated

2 Heavy Duty 60° Diamond Cutting Modular Knurling Head - CNCKH-2-R



Cutting

Medium Diameter Cutting Range 1" to 5" (25mm to 125mm)

End feed range: .004" to .016"

- Knurl cutting action
- Two straight R series knurl wheels for male diamond pattern
- Supplied with Full Faced RS-25-HS knurl wheels - TiN coated

3 Extra Heavy Duty 60° Diamond Cutting Modular Knurling Head - CNCKH-3-M



Cutting

Large Diameter Cutting Range 2" & up (50mm & up)

End feed range: .004" to .025"

- Knurl cutting action
- Two straight M series knurl wheels for male diamond pattern
- Supplied with Full Faced MS-25-HS knurl wheels - TiN coated

4 Double Wheel Forming Knurling Modular Head - CNCKH-4-M



Forming

Diameter Range: 5/16" & up (8mm & up)

End feed range: .004" to .012"

- Knurl Forming action
- Two M series knurl wheels for straight or diamond pattern
- Supplied with Beveled MDR/L-25-HSB knurl wheels - TiN coated

5 Single Wheel Forming Modular Knurling Head - CNCKH-5-O



Forming

Straight Bump Unlimited Diameter

End feed range: .004" to .012"

- Knurl forming action
- Single O series knurl wheel for straight or diamond pattern
- Supplied with Beveled OS-25-HSB knurl wheel - TiN coated

6 Shoulder Forming Modular Knurling Head - CNCKH-6-4



Forming

Diameter Range: 5/16" & up (8mm & up)

End feed range: .004" to .012"

- Knurl forming action
- Two SW series knurl wheels for straight or diamond pattern
- Supplied with Beveled SW4R/L-25-HSB knurl wheels - TiN coated

7 Straddle Forming Modular Knurling Head - CNCKH-7-R



Forming

Diameter Range: up to 1" (25mm)

End feed range: .004" to .012"

- Knurl forming action
- Two R series knurl wheels for straight or diamond pattern
- Supplied with Beveled RDR/L-30-HSB knurl wheels - TiN coated

7-2 Shoulder Style Straddle Forming Modular Knurling Head - CNCKH-7-2



Forming

Diameter Range: up to 1" (25mm)

End feed range: .004" to .012"

- Knurl forming action
- Two SW series knurl wheels for straight or diamond pattern
- Supplied with Beveled SW2R/L-30-HSB knurl wheels - TiN coated

1 Light Duty 60° Diamond Cutting Modular Knurling Head + CNC Modular Knurling Tool Shank



Metric		Shank Size mm	Tool Length	Inch		Shank Size	Tool Length	Knurl Wheel	Knurl Pin Set		Modular Head Description
Description	UPC #			Description	UPC #				Description	UPC #	
CNC-20-1-2	20405	20	174.65	CNC-75-1-2	20410	.750"	6 7/8"	SW2	SW2.0P-2S	29055	CNCKH-1-2
CNC-25-1-2	20415	25	174.65	CNC-100-1-2	20420	1.000"	6 7/8"	SW2			
CNC-32-1-2	20425	32	187.325	CNC-125-1-2	20430	1.250"	7 3/8"	SW2			

Supplied with a set of Full Faced straight high speed TiN coated knurl wheels, 30 TPI (.8mm) for a male diamond pattern.

2 Heavy Duty 60° Diamond Cutting Modular Knurling Head + CNC Modular Knurling Tool Shank



Metric		Shank Size mm	Tool Length	Inch		Shank Size	Tool Length	Knurl Wheel	Knurl Pin Set		Modular Head Description
Description	UPC #			Description	UPC #				Description	UPC #	
CNC-20-2-R	20505	20	174.65	CNC-75-2-R	20510	.750"	6 7/8"	Series R	KPS-25- 87-C	28925	CNCKH-2-R
CNC-25-2-R	20515	25	174.65	CNC-100-2-R	20520	1.000"	6 7/8"				
CNC-32-2-R	20525	32	187.325	CNC-125-2-R	20530	1.250"	7 3/8"				

Supplied with a set of Full Faced straight high speed knurl wheels, 25 TPI (1mm) for a male diamond pattern.

3 Extra Heavy Duty 60° Diamond Cutting Modular Knurling Head + CNC Modular Knurling Tool Shank

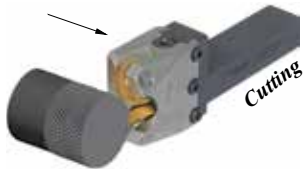

Metric		Shank Size mm	Tool Length	Inch		Shank Size	Tool Length	Knurl Wheel	Knurl Pin Set		Modular Head Description
Description	UPC #			Description	UPC #				Description	UPC #	
CNC-20-3-M	20605	20	177.8	CNC-75-3-M	20610	.750"	7"	Series M	KPS-31-100-C	28945	CNCKH-3-M
CNC-25-3-M	20615	25	177.8	CNC-100-3-M	20620	1.000"	7"				
CNC-32-3-M	20625	32	190.5	CNC-125-3-M	20630	1.250"	7 1/2"				

Supplied with a set of Full Faced straight high speed TiN coated knurl wheels, 25 TPI (1mm) for a male diamond pattern.

4 Double Wheel Forming Modular Knurling Head + CNC Modular Knurling Tool Shank

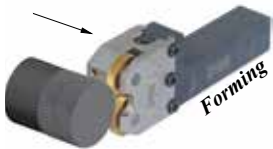

Metric		Shank Size mm	Tool Length	Inch		Shank Size	Tool Length	Knurl Wheel	Knurl Pin Set		Modular Head Description
Description	UPC #			Description	UPC #				Description	UPC #	
CNC-20-4-M	20640	20	177.8	CNC-75-4-M	20646	.750"	7"	Series M	KPS-31-125-C	28950	CNCKH-4-M
CNC-25-4-M	20642	25	177.8	CNC-100-4-M	20648	1.000"	7"				
CNC-32-4-M	20644	32	190.5	CNC-125-4-M	20650	1.250"	7 1/2"				

Supplied with a set of Beveled diagonal high speed beveled TiN coated knurl wheels, 25 TPI (1mm) for a male diamond pattern.

5 Single Wheel Forming Modular Knurling Head + CNC Modular Knurling Tool Shank



Metric		Shank Size mm	Tool Length	Inch		Shank Size	Tool Length	Knurl Wheel	Knurl Pin Set		Modular Head Description
Description	UPC #			Description	UPC #				Description	UPC #	
CNC-20-5-O	20705	20	171.45	CNC-75-5-O	20710	.750"	6 3/4"	Series O	KPS-31-125-C	28950	CNCKH-5-O
CNC-25-5-O	20715	25	171.45	CNC-100-5-O	20720	1.000"	6 3/4"				
CNC-32-5-O	20725	32	184.15	CNC-125-5-O	20730	1.250"	7 1/4"				

Supplied with one Beveled straight high speed beveled TiN coated knurl wheel, 25 TPI (1mm) for a straight pattern.

6 Shoulder Forming Modular Knurling Head + CNC Modular Knurling Tool Shank

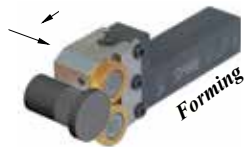

Metric		Shank Size mm	Tool Length	Inch		Shank Size	Tool Length	Knurl Wheel	Knurl Pin Set		Modular Head Description
Description	UPC #			Description	UPC #				Description	UPC #	
CNC-20-6-4	20775	20	171.45	CNC-75-6-4	20780	.750"	6 3/4"	Series SW4	SW4.0P-2S	29085	CNCKH-6-4
CNC-25-6-4	20785	25	171.45	CNC-100-6-4	20790	1.000"	6 3/4"				
CNC-32-6-4	20795	32	184.15	CNC-125-6-4	20800	1.250"	7 1/4"				

Supplied with a set of Beveled diagonal high speed beveled TiN coated knurl wheels, 25 TPI (1mm) for a male diamond pattern.

7-R Straddle Forming Modular Knurling Head + CNC Modular Knurling Tool Shank

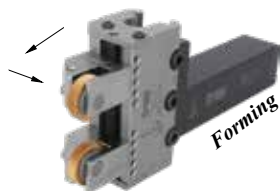

Metric		Shank Size mm	Tool Length	Inch		Shank Size	Tool Length	Knurl Wheel	Knurl Pin Set		Modular Head Description
Description	UPC #			Description	UPC #				Description	UPC #	
CNC-20-7-R	20905	20	187.325	CNC-75-7-R	20910	.750"	7 1/8"	Series R	KPS-25-75-C	28915	CNCKH-7-R
CNC-25-7-R	20915	25	187.325	CNC-100-7-R	20920	1.000"	7 3/8"				
CNC-32-7-R	20925	32	187.325	CNC-125-7-R	20930	1.250"	7 7/8"				

Supplied with a set of Beveled diagonal high speed beveled TiN coated knurl wheels, 30 TPI (.8mm) for a male diamond pattern.

7-2 Shoulder Style Straddle Forming Knurling Head + CNC Modular Knurling Tool Shank

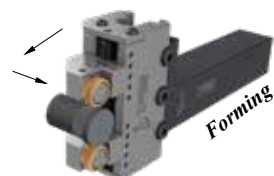

Metric		Shank Size mm	Tool Length	Inch		Shank Size	Tool Length	Knurl Wheel	Knurl Pin Set		Modular Head Description
Description	UPC #			Description	UPC #				Description	UPC #	
CNC-20-7-2	20935	20	182.88	CNC-75-7-2	20940	.750"	7 1/8"	Series SW2	SW2.0P-2S	29055	CNCKH-7-2
CNC-25-7-2	20945	25	182.88	CNC-100-7-2	20950	1.000"	7 1/8"				
CNC-32-7-2	20955	32	193.675	CNC-125-7-2	20960	1.250"	7 5/8"				

Supplied with a set of Beveled diagonal high speed beveled TiN coated knurl wheels, 30 TPI (.8mm) for a male diamond pattern.

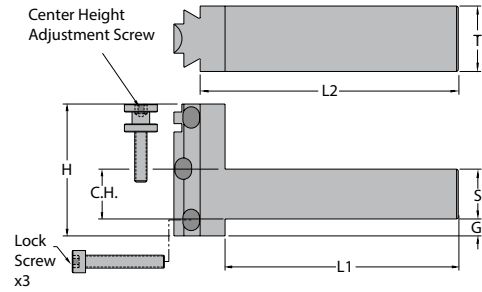

CNC Modular Knurling Tool Shank

Shank Inch		C.H. & S inch	G	H	L1	L2	T	Adjustment Screw		Lock Screw Set of 3	
Description	UPC #							Description	UPC #	Description	UPC #
CNC-75*	21010	0.750"	0.250	2.000	4.500	4.875	1.000	CNC-1175	28505	CNC-1024**	28515
CNC-100*	21020	1.000"	-	2.000	4.500	4.875	1.000				
CNC-125*	21030	1.250"	-	2.250	5.000	5.375	1.000				

Shank Metric		C.H. & S inch	G	H	L1	L2	T	Adjustment Screw		Lock Screw Set	
Description	UPC #							Description	UPC #	Description	UPC #
CNC-20*	21005	20mm	5.4	50.0	114.3	123.8	25.4	CNC-1175	28505	CNC-1024**	28515
CNC-25*	21015	25mm	-	50.0	114.3	123.8	25.4				
CNC-32*	21025	32mm	-	57.2	127.0	136.5	25.4				

* Supplied with lock screw set and adjustment screw

** One (1) set includes three (3) lock screws

CNC Knurling Heads

Cutting

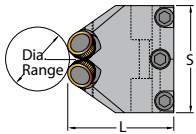
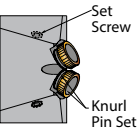
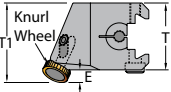

1 Light Duty 60° Diamond Cutting Knurling Head

Head Description	UPC #	System	Dia. Range	E	L	S	T	T1	Knurl Wheel Series	Knurl Pin Set		Set Screw
										Description	UPC #	
CNCKH-1-2	21035	inch	.500" to 1.500"	0.250	1.960	2.000	1.250	1.500	SW2*	SW2.0P-2S**	29055	M4-.7x4
		mm	12 to 38mm	6.4	49.8	50.8	31.8	38.1				

* Supplied with two (2) full faced straight high speed TiN coated knurl wheels for a male diamond pattern, 30 TPI (0.8mm)
** One (1) set includes two (2) knurling pins and washers

Male 60° diamond pattern with straight wheels.



Cutting

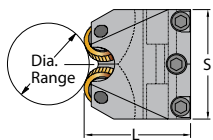
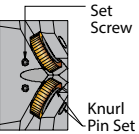
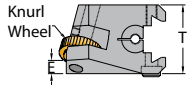

2 Heavy Duty 60° Diamond Cutting Knurling Head

Head Description	UPC #	System	Dia. Range	E	L	S	T	Knurl Wheel Series	Knurl Pin Set		Set Screw
									Description	UPC #	
CNCKH-2-R	21040	inch	1.00" to 5.00"	0.312	1.960	2.000	1.250	R*	KPS-25-87-C**	28925	M4-.7x4
		mm	25 to 127mm	7.9	49.8	50.8	31.8				

* Supplied with two (2) full faced straight high speed TiN coated knurl wheels for a male diamond pattern, 25 TPI (1.00mm)
** One (1) set includes one (1) knurling pin and two (2) washers

Male 60° diamond pattern with straight wheels.



Cutting

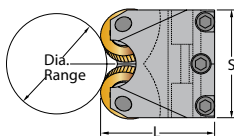
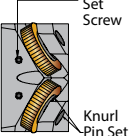
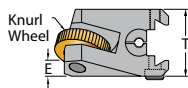

3 Extra H.D. 60° Diamond Cutting Knurling Head

Head Description	UPC #	System	Dia. Range	E	L	S	T	Knurl Wheel Series	Knurl Pin Set		Set Screw
									Description	UPC #	
CNCKH-3-M	21045	inch	2.0" & up	0.312	2.125	2.000	1.250	M*	KPS-31-100-C**	28945	M4-.7x4
		mm	50mm & up	7.9	54.0	50.8	31.8				

* Supplied with two (2) full faced straight high speed TiN coated knurl wheels for a male diamond pattern, 25 TPI (1.00mm)
** One (1) set includes one (1) pin and two (2) washers

Male 60° diamond pattern with straight wheels.



Forming

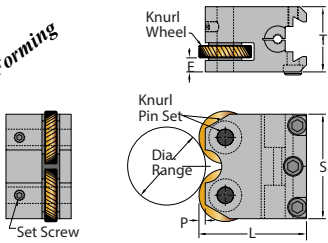

4 Double Wheel Forming Knurling Head

Head										Knurl Wheel Series	Knurl Pin Set		Set Screw
Description	UPC #	System	Dia. Range	E	L	P	S	T	Description		UPC #		
CNCKH-4-M	28947	inch	.313" & up***	0.265	2.125	0.120	2.000	1.250	M*	KPS-31-125-C**	28950	M5-.8x8	
		mm	8mm & up***	6.7	54.0	3.0	50.8	31.8					

* Supplied with one (1) set of beveled diagonal high speed TiN coated knurl wheels for a diamond pattern, 25 TPI (1.00mm)
 ** One (1) set includes one (1) knurling pin and two (2) washers
 *** Warning: May cause deflection on small part diameters, and too much pressure on large diameters

Straight pattern with straight wheels



Male 60° diamond pattern with diagonal wheels



Forming

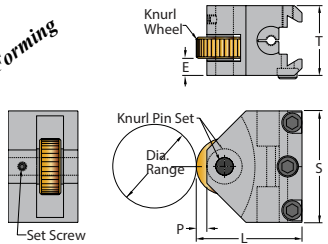

5 Single Wheel Forming Knurling Head

Head										Knurl Wheel Series	Knurl Pin Set		Set Screw
Description	UPC #	System	Dia. Range	E	L	P	S	T	Description		UPC #		
CNCKH-5-O	21050	inch	Unlimited***	0.312	1.875	0.188	2.000	1.250	O*	KPS-31-125-C**	28950	M4-.7x6	
		mm	Unlimited***	7.9	47.6	4.7	50.8	31.8					

* Supplied with one (1) beveled straight TiN coated knurl wheel for a straight pattern, 25 TPI (1.00mm)
 ** One (1) set includes one (1) knurling pin and two (2) washers
 *** Warning: May cause deflection on small part diameters, and too much pressure on large diameters

Straight pattern with straight wheel



Female diamond pattern with male diamond wheel



Male diamond pattern with female diamond wheel



Forming

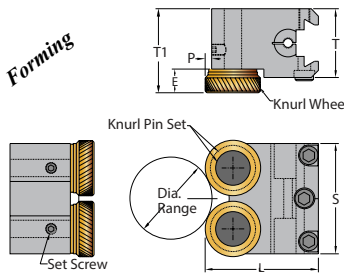

6 Shoulder Forming Knurling Head

Head											Knurl Wheel Series	Knurl Pin Set		Set Screw
Description	UPC #	System	Dia. Range	E	L	P	S	T	T1	Description		UPC #		
CNCKH-6-4	21056	inch	.312" & up***	0.375	1.875	0.050	2.000	1.250	1.500	SW4*	SW4.0P-2S**	29085	M5-.8x8	
		mm	8mm & up***	9.5	47.6	1.3	50.8	31.8	38.1					

* Supplied with one (1) set of beveled diagonal high speed TiN coated knurl wheels for a male diamond pattern, 25 TPI (1.00mm)
 ** One (1) set includes two (2) knurling pins and washers
 *** Warning: May cause deflection on small part diameters, and too much pressure on large diameters

Straight pattern with straight wheels



Male 60° diamond pattern with diagonal wheels



Forming

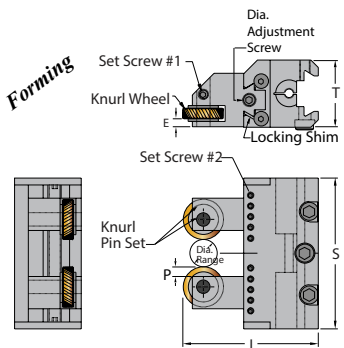

7 Straddle Forming Knurling Head

Head										Knurl Wheel Series	Knurl Pin Set		Set Screw #1	Set Screw #2
Description	UPC #	System	Dia. Range	E	L	P	S	T	Description		UPC #			
CNCKH-7-R	21060	inch	up to 1.0****	0.120	2.500	0.175	2.875	1.250	R*	KPS-25-75-C**	28920	M4-.7x4	M3-.5x3	
		mm	up to 25mm***	3.0	63.5	4.4	73.0	31.8						

* Supplied with one (1) set of beveled diagonal high speed TiN coated knurl wheels for a male diamond pattern, 30 TPI (0.8mm)
 ** One (1) set includes one (1) knurling pin and two (2) washers
 *** The tool has the capability to adjust the wheels until they touch, but physically applying a knurl on the smallest diameters may not be possible

Straight pattern with straight wheels



Male 60° diamond pattern with diagonal wheels



Forming

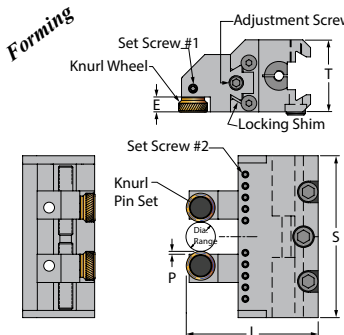

8 Straddle Forming Knurling Head

Head										Knurl Wheel Series	Knurl Pin Set		Set Screw #1	Set Screw #2
Description	UPC #	System	Dia. Range	E	L	P	S	T	Description		UPC #			
CNCKH-7-2	21065	inch	up to 1.0***	0.265	2.290	0.050	2.875	1.250	SW2*	SW2.0P-2S	29055	M4-.7x4	M3-.5x3	
		mm	up to 25mm***	6.7	58.2	1.3	73.0	31.8						

* Supplied with one (1) set of beveled diagonal high speed TiN coated knurl wheels to make a male diamond pattern, 30 TPI (0.8mm)
 ** One (1) set includes two (2) knurling pins and washers
 *** The tool has the capability to adjust the wheels until they touch, but physically applying a knurl on the smallest diameters may not be possible

Straight pattern with straight wheels



Male 60° diamond pattern with diagonal wheels



1 SMALL Light Duty 60° Diamond Cutting Modular Knurling Head - SCNCKH-1-2

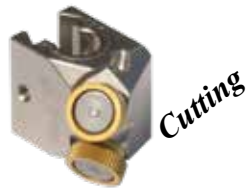

Small Cutting Range 1/2" to 1-1/2" (8mm to 38mm)

End feed range: .004" to .012"

- Knurl cutting action
- Twin straight SW series knurl wheels for male diamond pattern
- Supplied with full faced SW2S-30-HS knurl wheels - TiN coated

6 SMALL Shoulder Forming Modular Knurling Head - SCNCKH-6-2



Diameter Range: 1/4" & up (6,4mm & up)

End feed range: .004" to .012"

- Knurl forming action
- Twin SW series knurl wheels for straight or diamond pattern
- Supplied with beveled SW2R/L-25-HSB knurl wheels - TiN coated

7-R SMALL Straddle Forming Modular Knurling Head - SCNCKH-7-D

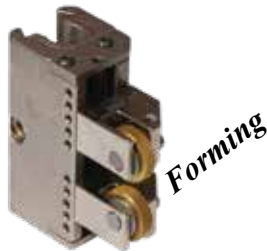

Diameter Range: up to 5/8" (16mm)

End feed range: .004" to .012"

- Knurl forming action
- Twin D series knurl wheels for straight or diamond pattern
- Supplied with beveled DR/L-30-HSB knurl wheels - TiN coated

7-2 SMALL Shoulder Style Straddle Forming Modular Knurling Head - SCNCKH-7-2

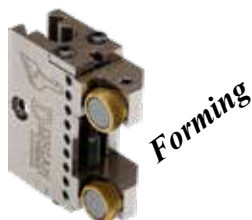

Diameter Range: up to 5/8" (16mm)

End feed range: .004" to .012"

- Knurl forming action
- Twin SW series knurl wheels for straight or diamond pattern
- Supplied with beveled SW2R/L-30-HSB knurl wheels - TiN coated



1 SMALL Light Duty 60° Diamond Cutting Modular Knurling Head + SMALL CNC Modular Knurling Tool Shank



Metric			Tool Length	Inch			Tool Length	Knurl Wheel	Knurl Pin Set		Modular Head Description
Description	UPC #	Shank Size mm		Description	UPC #	Shank Size			Description	UPC #	
SCNC-10-1-2	20005	10	4"	SCNC-37-1-2	20010	3/8"	4"	SW2			
SCNC-12-1-2	20015	12	4-1/4"	SCNC-50-1-2	20020	1/2"	4-1/4"	SW2	SW2.0P-2S	29055	SCNCKH-1-2
SCNC-162-1-2	20025	16	4-1/4"	SCNC-162-1-2	20025	5/8"	4-1/4"	SW2			

Supplied with a set of Full Faced straight high speed TiN coated knurl wheels, 30 TPI (.8mm) for a male diamond pattern

6 SMALL Shoulder Forming Modular Knurling Head + SMALL CNC Modular Knurling Tool Shank

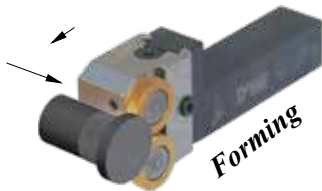

Metric			Tool Length	Inch			Tool Length	Knurl Wheel	Knurl Pin Set		Modular Head Description
Description	UPC #	Shank Size mm		Description	UPC #	Shank Size			Description	UPC #	
SCNC-10-6-2	20105	10	101.6	SCNC-37-6-2	20110	3/8"	4"	Series SW4	SW2.0P-2S	29055	SCNCKH-6-2
SCNC-12-6-2	20115	12	107.95	SCNC-50-6-2	20120	1/2"	4-1/4"				
SCNC-162-6-2	20125	16	107.95	SCNC-162-6-2	20125	5/8"	4-1/4"				

Supplied with a set of Beveled diagonal high speed TiN coated knurl wheels, 25 TPI (1mm) for a male diamond pattern

7-D SMALL Straddle Forming Modular Knurling Head + SMALL CNC Modular Knurling Tool Shank



Metric			Tool Length	Inch			Tool Length	Knurl Wheel	Knurl Pin Set		Modular Head Description
Description	UPC #	Shank Size mm		Description	UPC #	Shank Size			Description	UPC #	
SCNC-10-7-D	20205	10	114.3	SCNC-37-7-D	20210	3/8"	4-1/2"	Series D	KPS-18-50-C	28905	SCNCKH-7-D
SCNC-12-7-D	20215	12	120.65	SCNC-50-7-D	20220	1/2"	4-3/4"				
SCNC-162-7-D	20225	16	120.65	SCNC-162-7-D	20225	5/8"	4-3/4"				

Supplied with a set of Beveled diagonal high speed TiN coated knurl wheels, 30 TPI (8mm) for a male diamond pattern

7-2 SMALL Shoulder Style Straddle Forming Modular Knurling Head + SMALL CNC Modular Knurling Tool Shank

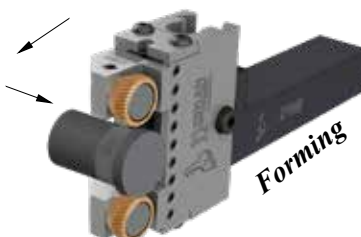

Metric			Tool Length	Inch			Tool Length	Knurl Wheel	Knurl Pin Set		Modular Head Description
Description	UPC #	Shank Size mm		Description	UPC #	Shank Size			Description	UPC #	
SCNC-10-7-2	20275	10	114.3	SCNC-37-7-2	20280	3/8"	4 1/2"	Series SW2	SW2.0P-2S	29055	SCNCKH-8-2
SCNC-12-7-2	20285	12	120.65	SCNC-50-7-2	20290	1/2"	4 3/4"				
SCNC-162-7-2	20295	16	120.65	SCNC-162-7-2	20295	5/8"	4 3/4"				

Supplied with a set of Beveled diagonal high speed TiN coated knurl wheels, 30 TPI (.8mm) for a male diamond pattern

SMALL CNC Modular Knurling Tool Shank



- Easy set-up
- High productivity
- Best knurl quality
- Long knurl wheel life
- Low production cost
- Specifically designed for the CNC Lathe
- Precision square shank with preset center height
- Right or Left hand applications
- Shanks and heads are all interchangeable
- High Speed knurl wheels (TiN coated)
- Carbide knurl pin
- Center height adjustment

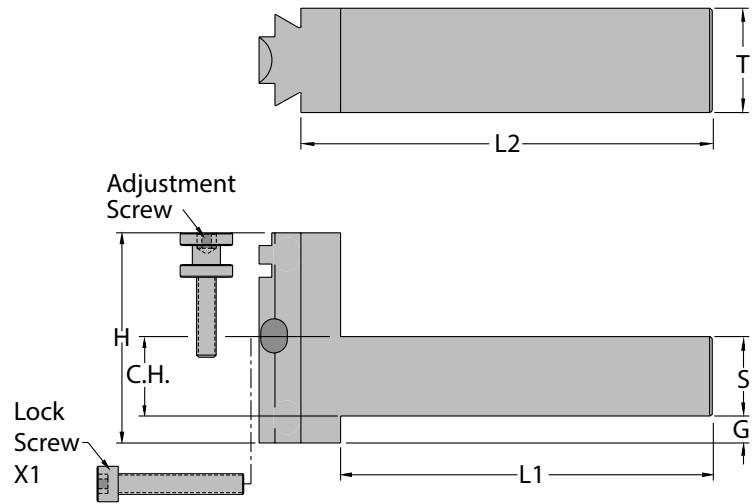

Shank Inch	UPC #	C.H. & S	G	H	L1	L2	T	Adjustment Screw		Lock Screw	
								Description	UPC #	Description	UPC #
SCNC-37*	20310	0.375"	0.115	1.000	2.500	2.685	0.750				
SCNC-50*	20320	0.500"	0.000	1.000	2.750	2.935	0.750	SCNC-875	28510	SCNC-832	28520
SCNC-162*	20325	0.625"	0.000	1.125	2.750	2.935	0.750				

Shank metric	UPC #	C.H. & S	G	H	L1	L2	T	Adjustment Screw		Lock Screw Set of 3	
								Description	UPC #	Description	UPC #
SCNC-10	20305	10	2.4	25.4	63.5	68.2	19.1				
SCNC-12	20315	12	0.4	25.4	69.9	74.5	19.1	SCNC-875	28510	SCNC-832	28520
SCNC-162	20325	16	0.0	28.6	69.9	74.5	19.1				

* Modular shank supplied with adjustment screw and screw lock

Cutting

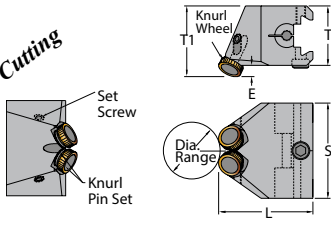



1 SMALL Light Duty 60° Diamond Cutting Knurling Head

Head	UPC #	System	Dia. Range	E	L	S	T	T1	Knurl Wheel Series	Knurl Pin Set		Set Screw
										Description	UPC #	
SCNCKH-1-2	20335	inch	.500" to 1.500"	0.200	1.350	1.000	0.750	0.950	SW2*	SW2.0P-2S**	29055	M4-.7x4
		mm	12 to 38 mm	5.1	34.3	25.4	19.1	24.1				
*Supplied with one (1) set of full faced straight high speed TiN coated knurl wheels for a male diamond pattern, 30 TPI (0.8mm) ** One (1) set includes two (2) knurling pins and washers										Male 60° diamond pattern with straight wheels		

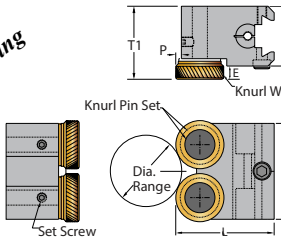
Forming





6 SMALL Shoulder Forming Knurling Head

Head	UPC #	System	Dia. Range	E	L	P	S	T	T1	Knurl Wheel Series	Knurl Pin Set		Set Screw			
											Description	UPC #				
SCNCKH-6-2	20340	inch	.250" & up ***	0.040	1.270	0.050	1.000	0.750	0.790	SW2*	SW2.0P-2S**	29055	M3-.5x3			
		mm	6.4mm & up ***	1.0	32.3	1.3	25.4	19.1	20.1							
* Supplied with one (1) set of beveled diagonal high speed TiN coated knurl wheels for a male diamond pattern, 30 TPI (0.8mm) ** One (1) set includes two (2) knurling pins and washers *** Warning: May cause deflection on small part diameters, and too much pressure on large diameters										Straight pattern with straight wheels			Male 60° diamond pattern with diagonal wheels			

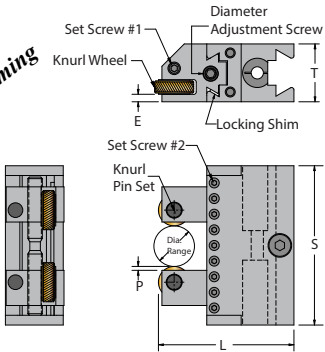
Forming





7 SMALL Straddle Forming Knurling Head

Head	UPC #	System	Dia. Range	E	L	P	S	T	Knurl Wheel Series	Knurl Pin Set		Set Screw				
										Description	UPC #	#1	#2			
SCNCKH-7-D	20345	inch	up to .625***	0.125	1.815	0.098	2.062	0.750	D*	KPS-18-50-C**	28905	M4-.7x4	M3-.5x3			
		mm	up to 16mm***	3.2	46.1	2.5	52.4	19.1								
* Supplied with one (1) set of beveled diagonal high speed TiN coated knurl wheels for a male diamond pattern, 30 TPI (0.8mm) ** One (1) set includes one (1) knurling pin and two (2) washers *** Warning: The tool has the capability to adjust the wheels until they touch, but physically applying a knurl on the smallest diameters may not be possible										Straight pattern with straight wheels			Male 60° diamond pattern with diagonal wheels			

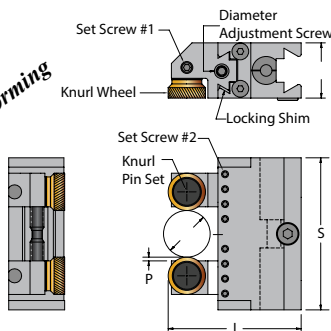
Forming



8 SMALL Shoulder Style Straddle Forming Modular Knurling Head

Head	UPC #	System	Dia. Range	E	L	P	S	T	Knurl Wheel Series	Knurl Pin Set		Set Screw				
										Description	UPC #	#1	#2			
SCNCKH-7-2	20346	inch	up to .625***	0.265	1.780	0.050	2.062	0.750	SW2*	SW2.0P-2S**	29055	M4-.7x4	M3-.5x3			
		mm	up to 16mm***	6.7	45.2	1.3	52.4	19.1								
*Supplied with one (1) set of beveled diagonal high speed TiN coated knurl wheels to make a male diamond pattern, 30 TPI (0.8mm) **One (1) set includes two (2) knurling pins and washers ***The tool has the capability to adjust the wheels until they touch, but physically applying a knurl on the smallest diameters may not be possible.										Straight pattern with straight wheels			Male 60° diamond pattern with diagonal wheels			

Straight Cutting Knurling Tool

107ST - Straight Cutting Knurling Tool With A Square Shank For CNC



- Knurl cutting action exerts minimum stress on the machine, and is faster than knurl forming action
- Single diagonal R or M series knurl wheel for a straight pattern
- Higher rigidity for larger diameters
- Knurl wheel is mounted between thrust washers to ensure a smooth and even rotation of the knurl
- Right or left hand shank
- Preset center height for CNC

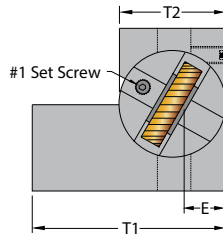

Resulting Knurl Pattern

Straight pattern with diagonal Left Hand wheel



Left

Recommended Use:

For best results, use sharp (full faced) knurl wheel. In-feed the knurl 1/8" on end of the part until the correct pattern is generated, then end-feed.

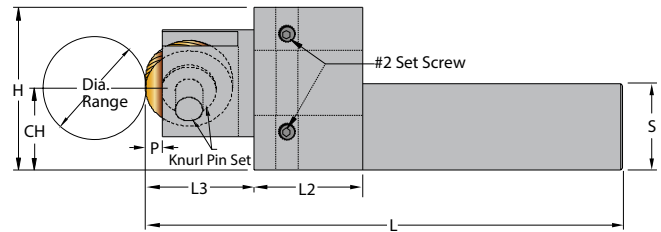
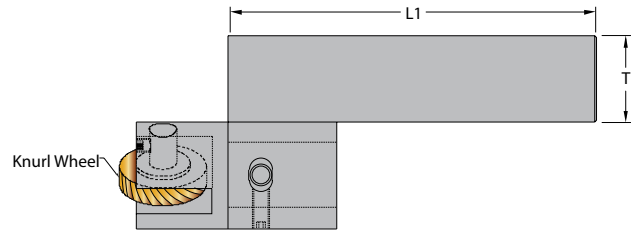

Inch Description	UPC #		CH & S inch	Dia. Range	E	H	L	L1	L2	L3	P	T	T1	T2	Knurl Wheel Series	Knurl Pin Set		Set Screw	
	R.H.	L.H.														Desc.	UPC #	No. 1	No. 2
107ST-50-R-RH/LH	21110	21210	0.500	Unlimited***	.375	1.375	3.875	3.000	1.250	0.875	.125	0.500	1.500	1.000	RDL*	KPS-25-100-C	28930	M4-.7x4	M5-.8x8
107ST-162-R-RH/LH	21115	21215	0.625	Unlimited***	.375	1.500	3.875	3.000	1.250	0.875	.125	0.625	1.625	1.000	RDL*	KPS-25-100-C	28930	M4-.7x4	M5-.8x8
107ST-75-M-RH/LH	21130	21230	0.750	Unlimited***	.480	1.625	4.500	3.250	1.250	1.250	.190	0.750	2.000	1.250	MDL**	KPS-31-125-C	28950	M4-.7x4	M5-.8x12
107ST-100-M-RH/LH	21140	21240	1.000	Unlimited***	.480	1.875	5.500	4.250	1.250	1.250	.190	1.000	2.250	1.250	MDL**	KPS-31-125-C	28950	M4-.7x4	M5-.8x12
107ST-125-M-RH/LH	21150	21250	1.250	Unlimited***	.480	2.125	6.000	4.750	1.250	1.250	.190	1.250	2.500	1.250	MDL**	KPS-31-125-C	28950	M4-.7x4	M5-.8x12

Metric Description	UPC #		CH & S mm	Dia. Range	E	H	L	L1	L2	L3	P	T	T1	T2	Knurl Wheel Series	Knurl Pin Set		Set Screw	
	R.H.	L.H.														Desc.	UPC #	No. 1	No. 2
107ST-12-R-RH/LH	21105	21205	12	Unlimited***	9.53	34.93	98.43	76.20	31.75	22.23	3.18	12.70	38.10	25.40	RDL*	KPS-25-100-C	28930	M4-.7x4	M5-.8x8
107ST-162-R-RH/LH	21115	21215	16	Unlimited***	9.53	38.10	98.43	76.20	31.75	22.23	3.18	15.88	41.28	25.40	RDL*	KPS-25-100-C	28930	M4-.7x4	M5-.8x8
107ST-20-M-RH/LH	21125	21225	20	Unlimited***	12.19	41.28	114.30	82.55	31.75	31.75	4.83	19.05	50.80	31.75	MDL**	KPS-31-125-C	28950	M4-.7x4	M5-.8x12
107ST-25-M-RH/LH	21135	21235	25	Unlimited***	12.19	47.63	139.70	107.95	31.75	31.75	4.83	25.40	57.15	31.75	MDL**	KPS-31-125-C	28950	M4-.7x4	M5-.8x12
107ST-32-M-RH/LH	21145	21245	32	Unlimited***	12.19	53.98	152.40	120.65	31.75	31.75	4.83	31.75	63.50	31.75	MDL**	KPS-31-125-C	28950	M4-.7x4	M5-.8x12

Supplied with one (1) full faced diagonal left high speed TiN coated knurl wheel, * 30 TPI (.8mm), ** 25 TPI (1.0mm)

*** Warning: May cause deflection on small part diameters, and too much pressure on large diameters

107ST - Straight Cutting Shoulder Knurling Tool With A Square Shank For CNC



- Knurl cutting action exerts minimum stress on the machine, and is faster than knurl forming action
- Single diagonal SW2 or SW4 series knurl wheel for a straight pattern
- For knurling closer to a shoulder
- Knurl wheel is mounted on a thrust washer to ensure a smooth and even rotation of the knurl
- Right or left hand shank
- Preset center height for CNC

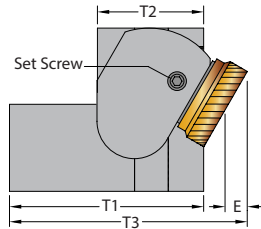

Resulting Knurl Pattern

Straight pattern with diagonal Left Hand wheel



Left

Recommended Use:

For best results, use sharp (full faced) knurl wheel. In-feed the knurl 1/8" on end of the part until the correct pattern is generated, then end-feed.

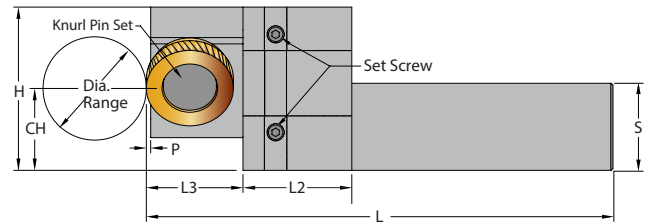
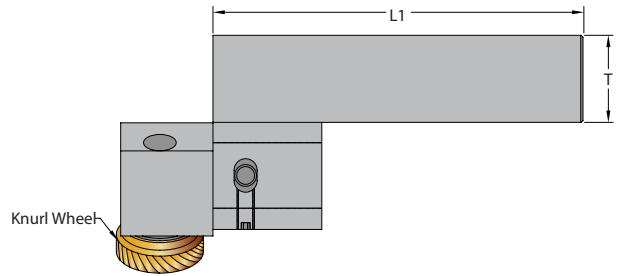

Inch Description	UPC #		CH & S inch	Dia. Range	E	H	L	L1	L2	L3	P	T	T1	T2	T3	Knurl Wheel Series	Knurl Pin Set		
	R.H.	L.H.															Description	UPC #	Set Screw
107ST-50-2-RH/LH	21111	21211	0.500	Unlimited***	0.125	1.375	3.875	3.000	1.250	0.875	0.050	0.500	1.500	1.000	1.750	SW2L*	SW2.0P-1S	29050	M3-.5x4
107ST-162-2-RH/LH	21116	21216	0.625	Unlimited***	0.125	1.500	3.875	3.000	1.250	0.875	0.050	0.625	1.625	1.000	1.875	SW2L*	SW2.0P-1S	29050	M3-.5x4
107ST-75-4-RH/LH	21131	21231	0.750	Unlimited***	0.250	1.625	4.500	3.250	1.250	1.250	0.050	0.750	2.000	1.250	2.500	SW4L**	SW4.0P-1S	29080	M5-.8x5
107ST-100-4-RH/LH	21141	21241	1.000	Unlimited***	0.250	1.875	5.500	4.250	1.250	1.250	0.050	1.000	2.250	1.250	2.750	SW4L**	SW4.0P-1S	29080	M5-.8x5
107ST-125-4-RH/LH	21151	21251	1.250	Unlimited***	0.250	2.125	6.000	4.750	1.250	1.250	0.050	1.250	2.500	1.250	3.000	SW4L**	SW4.0P-1S	29080	M5-.8x5

Metric Description	UPC #		CH & S mm	Dia. Range	E	H	L	L1	L2	L3	P	T	T1	T2	T3	Knurl Wheel Series	Knurl Pin Set		
	R.H.	L.H.															Description	UPC #	Set Screw
107ST-12-2-R/L	21106	21206	12	Unlimited***	3.2	34.9	98.4	76.2	31.8	22.2	1.3	12.7	38.1	25.4	44.5	SW2L*	SW2.0P-1S	29050	M3-.5x4
107ST-162-2-R/L	21116	21216	16	Unlimited***	3.2	38.1	98.4	76.2	31.8	22.2	1.3	15.9	41.3	25.4	47.6	SW2L*	SW2.0P-1S	29050	M3-.5x4
107ST-20-4-R/L	21126	21226	20	Unlimited***	6.4	41.3	114.3	82.6	31.8	31.8	1.3	19.1	50.8	31.8	63.5	SW4L**	SW4.0P-1S	29080	M5-.8x5
107ST-25-4-R/L	21136	21236	25	Unlimited***	6.4	47.6	139.7	108.0	31.8	31.8	1.3	25.4	57.2	31.8	69.9	SW4L**	SW4.0P-1S	29080	M5-.8x5
107ST-32-4-R/L	21146	21246	32	Unlimited***	6.4	54.0	152.4	120.7	31.8	31.8	1.3	31.8	63.5	31.8	76.2	SW4L**	SW4.0P-1S	29080	M5-.8x5

Supplied with one (1) full faced diagonal left high speed TiN coated knurl wheel, * 30 TPI (.8mm), ** 25 TPI (1.0mm)

*** Warning: May cause deflection on small part diameters, and too much pressure on large diameters

Face Forming Knurling Tool

FACEKT - Face Forming Knurling Tool

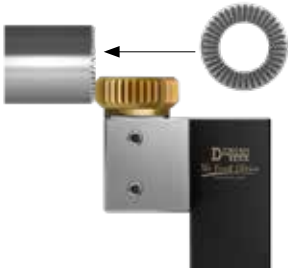

- Precision square shank with preset center height
- Single knurl wheel for straight or diamond pattern
- Knurl wheel is mounted on a thrust washer to ensure a smooth and even rotation of the knurl
- Specifically designed to knurl small width face knurl patterns, even up to a shoulder
- Head can be reversed for right or left hand operation

Resulting Knurl Pattern

Straight pattern with straight wheel



Straight

Male 60° diamond pattern with female wheel



Female

Recommended Use:

For best results, use beveled knurl wheels. In-feed (plunge) the knurling tool on to the blank face until the correct pattern is generated.

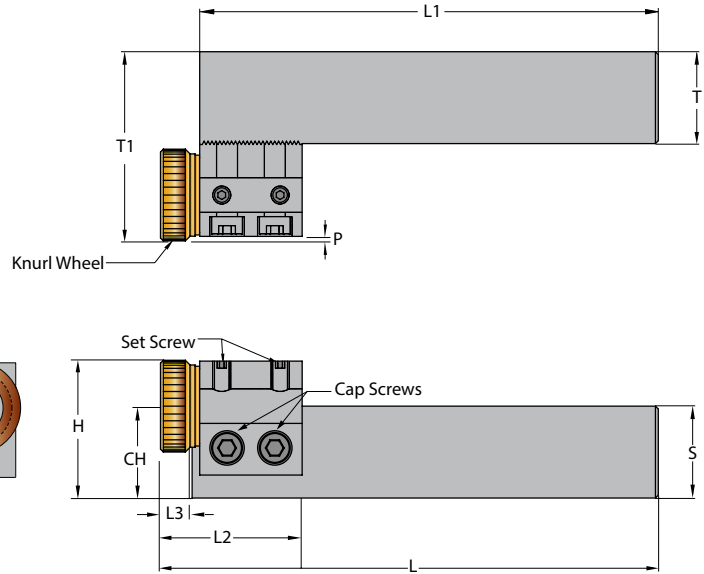
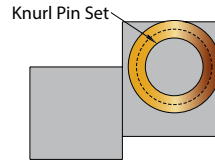

Inch		CH & S inch	Dia. Range	H	L	L1	L2	L3	P	T	T1	Knurl Wheel Series	Knurl Pin Set		Set Screw	Cap Screw
Description	UPC #												Description	UPC #		
FACEKT-75-2	21620	0.750	Unlimited***	1.000	4.375	4.100	1.375	0.265	0.050	0.750	1.530	SW2 *	SW2.0P-1S	29050	M3-.5x3	M5-.8x25
FACEKT-100-2	21630	1.000	Unlimited***	1.250	5.375	5.100	1.375	0.265	0.050	1.000	1.780	SW2 *	SW2.0P-1S	29050	M3-.5x3	M5-.8x25
FACEKT-75-4	21640	0.750	Unlimited***	1.250	4.500	4.100	1.500	0.405	0.050	0.750	1.780	SW4 **	SW4.0P-1S	29080	M5-.8x8	M5-.8x25
FACEKT-100-4	21650	1.000	Unlimited***	1.500	5.500	5.100	1.500	0.405	0.050	1.000	2.000	SW4 **	SW4.0P-1S	29080	M5-.8x8	M5-.8x25

Metric		CH & S mm	Dia. Range	H	L	L1	L2	L3	P	T	T1	Knurl Wheel Series	Knurl Pin Set		Set Screw	Cap Screw
Description	UPC #												Description	UPC #		
FACEKT-20-2	21615	20	Unlimited***	25.4	111.1	104.1	34.9	6.7	1.3	19.1	38.9	SW2 *	SW2.0P-1S	29050	M3-.5x3	M5-.8x25
FACEKT-25-2	21625	25	Unlimited***	31.8	136.5	129.5	34.9	6.7	1.3	25.4	45.2	SW2 *	SW2.0P-1S	29050	M3-.5x3	M5-.8x25
FACEKT-20-4	21635	20	Unlimited***	31.8	114.3	104.1	38.1	10.3	1.3	19.1	45.2	SW4 **	SW4.0P-1S	29080	M5-.8x8	M5-.8x25
FACEKT-25-4	21645	25	Unlimited***	38.1	139.7	129.5	38.1	10.3	1.3	25.4	50.8	SW4 **	SW4.0P-1S	29080	M5-.8x8	M5-.8x25

Supplied with one (1) beveled straight high speed TiN coated knurl wheel, * 30 TPI (.8mm), ** 25 TPI (1.0mm)
 *** Limited band width from knurl wheel

3SHKT - Three Swivel Head Forming Knurling Tool



- Precision square shank with preset center height
- Three sets of twin knurl wheels for straight or diamond pattern
- Knurl wheels are mounted between thrust washers to ensure a smooth and even rotation of the knurls
- Three pairs of knurl wheels to change pitch or pattern quickly
- Head can be reversed for right or left hand operation

Resulting Knurl Pattern

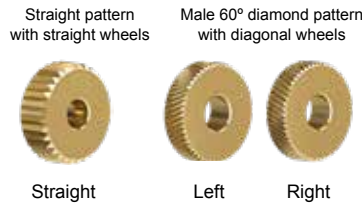

Recommended Use:

For best results, use beveled knurl wheels. In-feed the knurling tool into the blank until the correct pattern is generated, then end-feed.

Self-Center Knurling 3 Wheel Set

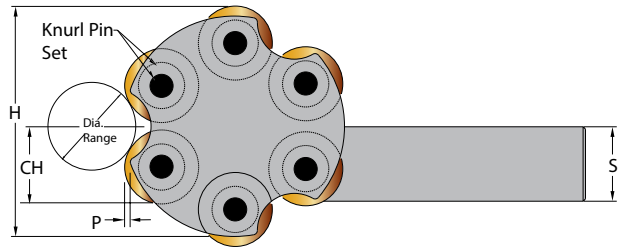
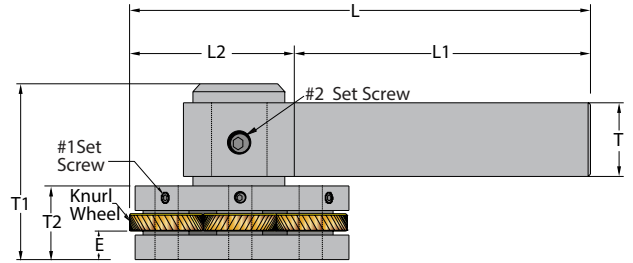
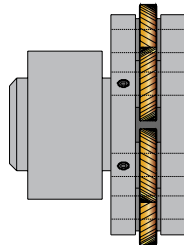

Inch Description	UPC #	CH & S inch	Dia. Range	E	H	L	L1	L2	P	T	T1	T2	Knurl Wheel Series	Knurl Pin Set		Set Screw		Spring & Ball Set	UPC #
														Description	UPC #	No. 1	No. 2		
3SHKT-50-D	21510	0.500	1/4" & up***	0.195	1.660	4.125	2.750	1.375	0.035	0.750	1.690	0.690	D *	KPS-18-62	28810	M3-.5x3	M6-1.00x6	STBL-18	28525
3SHKT-162-D	21515	0.625		0.195	1.660	4.125	2.750	1.375	0.035	0.750	1.690	0.690	D *	KPS-18-62	28810	M3-.5x3	M6-1.00x6	STBL-18	28525
3SHKT-75-M	21530	0.750	5/16" & up***	0.380	3.000	5.500	3.250	2.250	0.075	1.000	2.375	1.125	M **	KPS-31-100	28845	M4-.7x4	M8-1.25x8	STBL-25	28530
3SHKT-100-M	21540	1.000		0.380	3.000	6.250	4.000	2.250	0.075	1.000	2.375	1.125	M **	KPS-31-100	28845	M4-.7x4	M8-1.25x8	STBL-25	28530
3SHKT-125-M	21550	1.250		0.380	3.000	7.375	5.000	2.375	0.075	1.000	2.375	1.125	M **	KPS-31-100	28845	M4-.7x4	M8-1.25x8	STBL-25	28530

Metric Description	UPC #	CH & S mm	Dia. Range	E	H	L	L1	L2	P	T	T1	T2	Knurl Wheel Series	Knurl Pin Set		Set Screw		Spring & Ball Set	UPC #
														Description	UPC #	No. 1	No. 2		
3SHKT-12-D	21505	12	6.4mm & up***	5.0	42.2	104.8	69.9	34.9	0.9	19.1	42.9	17.5	D *	KPS-18-62	28810	M3-.5x3	M6-1.00x6	STBL-18	28525
3SHKT-162-D	21515	16		5.0	42.2	104.8	69.9	34.9	0.9	19.1	42.9	17.5	D *	KPS-18-62	28810	M3-.5x3	M6-1.00x6	STBL-18	28525
3SHKT-20-M	21525	20	8mm & up***	9.7	76.2	139.7	82.6	57.2	1.9	25.4	60.3	28.6	M **	KPS-31-100	28845	M4-.7x4	M8-1.25x8	STBL-25	28530
3SHKT-25-M	21535	25		9.7	76.2	158.8	101.6	57.2	1.9	25.4	60.3	28.6	M **	KPS-31-100	28845	M4-.7x4	M8-1.25x8	STBL-25	28530
3SHKT-32-M	21545	32		9.7	76.2	187.3	127.0	60.3	1.9	25.4	60.3	28.6	M **	KPS-31-100	28845	M4-.7x4	M8-1.25x8	STBL-25	28530

* Supplied with three (3) sets of beveled diagonal right and diagonal left high speed TiN coated knurl wheels, 20 TPI (1.2mm), 30 TPI (0.8mm), 40 TPI (0.6mm)

** Supplied with three (3) sets of beveled diagonal right and diagonal left high speed TiN coated knurl wheels, 16 TPI (1.6mm), 25 TPI (1.0mm), 35 TPI (0.7mm)

*** Warning: May cause deflection on small part diameters, and too much pressure on large diameters

Double Wheel Self-Centering Forming Knurling Tool

SCKN - Self-Centering Knurling Tool HD SCKN Heavy Duty Self-Centering Knurling Tool



- Specifically designed for CNC lathes
- Precision square shank with preset center height
- Twin knurl wheels for straight or diamond pattern
- Knurl wheels are mounted between thrust washers to ensure smooth & even rotation of knurls
- Self-centering knurling head for a precise alignment
- Head is reversible for right or left hand knurl application

Resulting Knurl Pattern

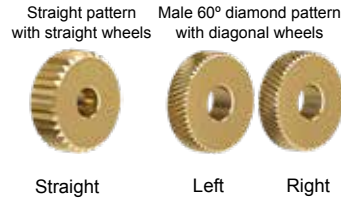

Recommended Use:

For best results, use beveled knurl wheels. In-feed the knurling tool into the blank until the right pattern is generated, then end-feed.

Self-Center Knurling Twin Wheel Set

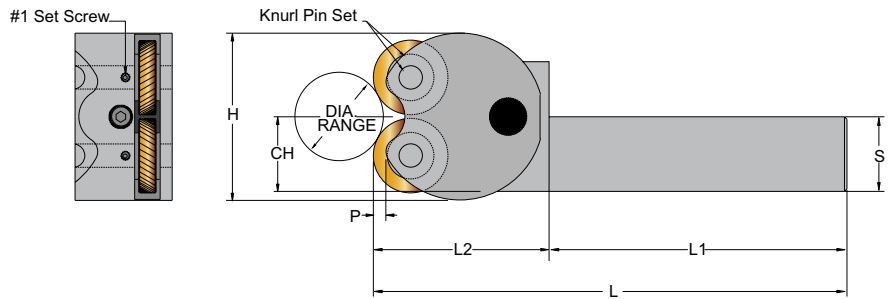
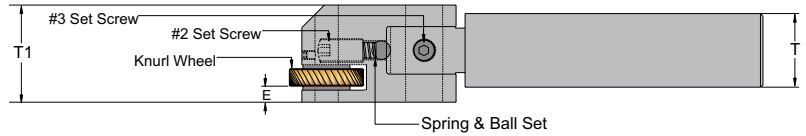

Inch			Dia. Range	Knurl Wheel								Knurl Pin Set			Set Screw			Spring & Ball Set	UPC #
Description	UPC #	CH & S inch		E	H	L	L1	L2	P	T	T1	Description	UPC #	No. 1	No. 2	No. 3			
SCKN-38-DW-D	22151	0.375	1/4" & up***	.115	1.375	3.875	2.500	1.375	0.030	0.500	0.750	D *	KPS-18-50	28805	M3-.5x3	M6-1.0x6	M5-.8x5	STBL-18	28525
SCKN-50-DW-D	22111	0.500		.115	1.375	4.125	2.750	1.375	0.030	0.625	0.750	D *	KPS-18-50	28805	M3-.5x3	M6-1.0x6	M5-.8x5	STBL-18	28525
SCKN-162-DW-D	22115	0.625		.115	1.375	4.375	3.000	1.375	0.030	0.625	0.750	D *	KPS-18-50	28805	M3-.5x3	M6-1.0x6	M5-.8x5	STBL-18	28525
SCKN-75-DW-M	22121	0.750	5/16" & up***	.211	2.250	5.625	3.250	2.375	0.170	0.750	1.312	M **	KPS-31-100	28845	M3-.5x3	M8-1.25x8	M6-1.0x12	STBL-25	28530
SCKN-100-DW-M	22131	1.000		.211	2.250	6.375	4.000	2.375	0.170	1.000	1.312	M **	KPS-31-100	28845	M3-.5x3	M8-1.25x8	M6-1.0x12	STBL-25	28530
SCKN-125-DW-M	22141	1.250		.211	2.250	7.375	5.000	2.375	0.170	1.250	1.312	M **	KPS-31-100	28845	M3-.5x3	M8-1.25x8	M6-1.0x12	STBL-25	28530
HD SCKN-75-DW-O	22410	0.750	3/4" & up***	.437	2.750	5.875	3.250	2.625	0.200	0.750	1.250	O **	KPS-31-125-C	28950	M4-.7x4	M8-1.25x8	M6-1.0x12	STBL-25	28530
HD SCKN-100-DW-O	22420	1.000		.437	2.750	6.625	4.000	2.625	0.200	1.000	1.250	O **	KPS-31-125-C	28950	M4-.7x4	M8-1.25x8	M6-1.0x12	STBL-25	28530
HD SCKN-100-DW-P	22430	1.000	1.0" & up ***	.375	3.250	6.875	4.000	2.875	0.125	1.000	1.250	P **	KPS-50-125-C	28955	M4-.7x6	M8-1.25x8	M6-1.0x12	STBL-25	28530
HD SCKN-125-DW-P	22440	1.250		.375	3.250	7.875	5.000	2.875	0.125	1.250	1.250	P **	KPS-50-125-C	28955	M4-.7x6	M8-1.25x8	M6-1.0x12	STBL-25	28530

Metric			Dia. Range	Knurl Wheel								Knurl Pin Set			Set Screw			Spring & Ball Set	UPC #
Description	UPC #	CH & S mm		E	H	L	L1	L2	P	T	T1	Description	UPC #	No. 1	No. 2	No. 3			
SCKN-10-DW-D	22161	10	6.4mm & up***	2.9	34.9	98.4	63.5	34.9	0.8	12.7	19.1	D *	KPS-18-50	28805	M3-.5x3	M6-1.0x6	M5-.8x5	STBL-18	28525
SCKN-12-DW-D	22106	12		2.9	34.9	104.8	69.9	34.9	0.8	15.9	19.1	D *	KPS-18-50	28805	M3-.5x3	M6-1.0x6	M5-.8x5	STBL-18	28525
SCKN-162-DW-D	22115	16		2.9	34.9	111.1	76.2	34.9	0.8	15.9	19.1	D *	KPS-18-50	28805	M3-.5x3	M6-1.0x6	M5-.8x5	STBL-18	28525
SCKN-20-DW-M	22116	20	8mm & up***	5.4	57.2	142.9	82.6	60.3	4.3	19.1	33.3	M **	KPS-31-100	28845	M3-.5x3	M8-1.25x8	M6-1.0x12	STBL-25	28530
SCKN-25-DW-M	22126	25		5.4	57.2	161.9	101.6	60.3	4.3	25.4	33.3	M **	KPS-31-100	28845	M3-.5x3	M8-1.25x8	M6-1.0x12	STBL-25	28530
SCKN-32-DW-M	22136	32		5.4	57.2	187.3	127.0	60.3	4.3	31.8	33.3	M **	KPS-31-100	28845	M3-.5x3	M8-1.25x8	M6-1.0x12	STBL-25	28530
HD SCKN-20-DW-O	22405	20	19mm & up***	11.1	69.9	149.2	82.6	66.7	5.1	19.1	31.8	O **	KPS-31-125-C	28950	M4-.7x4	M8-1.25x8	M6-1.0x12	STBL-25	28530
HD SCKN-25-DW-O	22415	25		11.1	69.9	168.3	101.6	66.7	5.1	25.4	31.8	O **	KPS-31-125-C	28950	M4-.7x4	M8-1.25x8	M6-1.0x12	STBL-25	28530
HD SCKN-25-DW-P	22425	25	25mm & up***	9.5	82.6	174.6	101.6	73.0	3.2	25.4	31.8	P **	KPS-50-125-C	28955	M4-.7x6	M8-1.25x8	M6-1.0x12	STBL-25	28530
HD SCKN-32-DW-P	22435	32		9.5	82.6	200.0	127.0	73.0	3.2	31.8	31.8	P **	KPS-50-125-C	28955	M4-.7x6	M8-1.25x8	M6-1.0x12	STBL-25	28530

Supplied with one (1) set of beveled diagonal high speed knurl wheels, *30 TPI (0.8mm), **25 TPI (1.0mm)
 *** Warning: May cause deflections on small part diameters, and too much pressure on large diameters

Double Wheel Shoulder Self-Centering Forming Knurling Tool

SSCK - Shoulder Self-Centering Knurling Tool

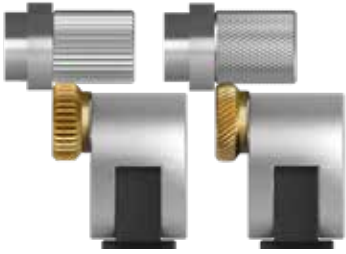

- Specifically designed for CNC lathes
- Designed to knurl against a square shoulder
- Precision square shank with preset center height
- Twin knurl wheels for straight or diamond pattern
- Knurl wheels are mounted on a thrust washer to ensure a smooth and even rotation of the knurl
- Self-centering knurling head for a precise alignment
- Head is reversible for right or left hand knurl application

Resulting Knurl Pattern

Straight pattern with straight wheels



Straight

Male 60° diamond pattern with diagonal wheels



Left

Right

Recommended Use:

For best results, use beveled knurl wheels. In-feed the knurling tool into the blank until the right pattern is generated, then end-feed.

Self-Center Knurling Twin Wheel Set

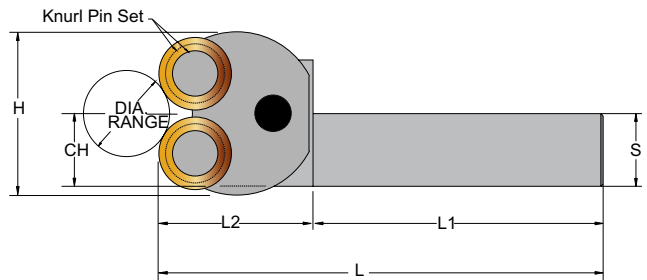
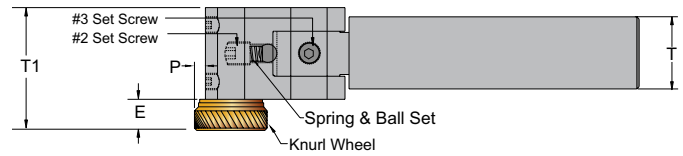
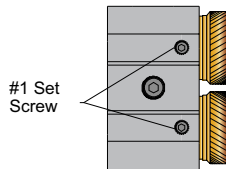

Inch		CH & S inch	Dia. Range	E	H	L	L1	L2	P	T	T1	Knurl Wheel Series	Knurl Pin Set		Set Screw			Spring & Ball Set	UPC #
Description	UPC #												Description	UPC #	No. 1	No. 2	No. 3		
SSCK-38-DW-2	22210	0.375	1/4" & up***	.265	1.375	3.875	2.500	1.375	0.050	0.500	1.015	SW2 *	SW2.0P-2S	29055	M3-.5x3	M6-1.0x6	M5-.8x5	STBL-18	28525
SSCK-50-DW-2	22220	0.500		.265	1.375	4.125	2.750	1.375	0.050	0.625	1.015	SW2 *	SW2.0P-2S	29055	M3-.5x3	M6-1.0x6	M5-.8x5	STBL-18	28525
SSCK-162-DW-2	22218	0.625		.265	1.375	4.375	3.000	1.375	0.050	0.625	1.015	SW2 *	SW2.0P-2S	29055	M3-.5x3	M6-1.0x6	M5-.8x5	STBL-18	28525
SSCK-75-DW-4	22240	0.750	5/16" & up***	.410	2.250	5.375	3.250	2.125	0.050	0.750	1.660	SW4 **	SW4.0P-2S	29085	M5-.8x5	M8-1.25x8	M6-1.0x12	STBL-25	28530
SSCK-100-DW-4	22250	1.000		.410	2.250	6.125	4.000	2.125	0.050	1.000	1.660	SW4 **	SW4.0P-2S	29085	M5-.8x5	M8-1.25x8	M6-1.0x12	STBL-25	28530
SSCK-125-DW-4	22260	1.250		.410	2.250	7.125	5.000	2.125	0.050	1.250	1.660	SW4 **	SW4.0P-2S	29085	M5-.8x5	M8-1.25x8	M6-1.0x12	STBL-25	28530
Metric		CH & S mm	Dia. Range	E	H	L	L1	L2	P	T	T1	Knurl Wheel Series	Knurl Pin Set		Set Screw			Spring & Ball Set	UPC #
Description	UPC #												Description	UPC #	No. 1	No. 2	No. 3		
SSCK-10-DW-2	22205	10	6.4mm & up***	6.7	34.9	98.4	63.5	34.9	1.3	12.7	22.6	SW2 *	SW2.0P-2S	29055	M3-.5x3	M6-1.0x6	M5-.8x5	STBL-18	28525
SSCK-12-DW-2	22215	12		6.7	34.9	104.8	69.9	34.9	1.3	15.9	22.6	SW2 *	SW2.0P-2S	29055	M3-.5x3	M6-1.0x6	M5-.8x5	STBL-18	28525
SSCK-162-DW-2	22218	16		6.7	34.9	111.1	76.2	34.9	1.3	15.9	22.6	SW2 *	SW2.0P-2S	29055	M3-.5x3	M6-1.0x6	M5-.8x5	STBL-18	28525
SSCK-20-DW-4	22235	20	8mm & up***	10.4	57.2	136.5	82.6	54.0	1.3	19.1	42.2	SW4 **	SW4.0P-2S	29085	M5-.8x5	M8-1.25x8	M6-1.0x12	STBL-25	28530
SSCK-25-DW-4	22245	25		10.4	57.2	155.6	101.6	54.0	1.3	25.4	42.2	SW4 **	SW4.0P-2S	29085	M5-.8x5	M8-1.25x8	M6-1.0x12	STBL-25	28530
SSCK-32-DW-4	22255	32		10.4	57.2	181.0	127.0	54.0	1.3	31.8	42.2	SW4 **	SW4.0P-2S	29085	M5-.8x5	M8-1.25x8	M6-1.0x12	STBL-25	28530

Supplied with one (1) set of beveled diagonal high speed TiN coated knurl wheels, *30 TPI (.8mm), **25 TPI (1.0mm)
 *** Warning: May cause deflection on small part diameters, and too much pressure on large diameters

Single Wheel Fixed Forming Knurling Tool

SWFKT - Single Wheel Fixed Forming Knurling Tool HDSWFKT - Heavy Duty Single Wheel Fixed Forming Knurling Tool



- Precision square shank with preset center height
- Single wheel knurling tool for general purposes
- Knurl wheel is mounted between thrust washers to ensure a smooth and even rotation of the knurls



Resulting Knurl Pattern

Straight pattern with straight wheel



Straight

Male 60° diamond pattern with female wheel



Female

Female 60° diamond pattern with male wheel



Male

Recommended Use:

For best results, use beveled knurl wheel. In-feed the knurling tool into the blank until the right pattern is generated, then end-feed for straight pattern. Do not end-feed for diamond pattern.

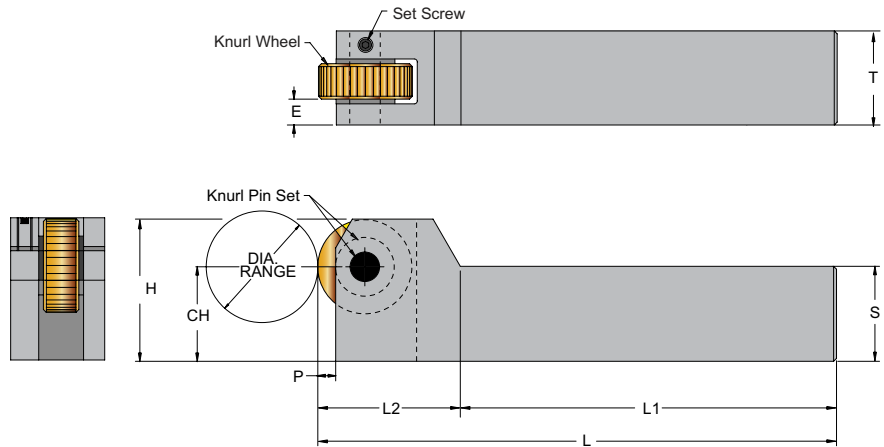

Inch Description	UPC #	CH & S inch	Dia. Range	E	H	L	L1	L2	P	T	Knurl Wheel Series	Knurl Pin Set		Set Screw
												Desc.	UPC #	
SWFKT-831-B	21705	0.312	Unlimited***	0.080	0.500	2.625	2.000	0.625	0.030	0.375	B *	KPS-12-38	28800	M3-5x3
SWFKT-38-D	21720	0.375	Unlimited***	0.150	0.625	3.375	2.500	0.875	0.060	0.500	D *	KPS-18-50	28805	M3-5x3
SWFKT-50-D	21730	0.500	Unlimited***	0.150	0.750	3.625	2.750	0.875	0.060	0.500	D *	KPS-18-50	28805	M3-5x3
SWFKT-162-D	21765	0.625	Unlimited***	0.150	0.875	4.000	3.000	1.000	0.060	0.625	D *	KPS-18-62	28810	M3-5x3
SWFKT-75-M	21740	0.750	Unlimited***	0.250	1.250	4.750	3.250	1.500	0.190	0.750	M **	KPS-31-75	28840	M3-5x5
SWFKT-100-O	21750	1.000	Unlimited***	0.280	1.500	5.500	4.000	1.500	0.190	1.000	O **	KPS-31-100	28845	M4-7x8
SWFKT-125-O	21760	1.250	Unlimited***	0.300	1.750	6.500	5.000	1.500	0.190	1.250	O **	KPS-31-125	28850	M5-8x8
HDSWFKT-75-O	21810	0.750	Unlimited***	0.260	1.250	4.750	3.250	1.500	0.190	1.000	O **	KPS-31-100-C	28945	M4-7x8
HDSWFKT-100-P	21820	1.000	Unlimited***	0.300	1.500	5.875	4.000	1.875	0.225	1.250	P **	KPS-50-125-C	28955	M5-8x8
HDSWFKT-125-P	21830	1.250	Unlimited***	0.300	1.750	6.750	5.000	1.750	0.225	1.250	P **	KPS-50-125-C	28955	M5-8x8

Metric Description	UPC #	CH & S mm	Dia. Range	E	H	L	L1	L2	P	T	Knurl Wheel Series	Knurl Pin Set		Set Screw
												Desc.	UPC #	
SWFKT-831-B	21705	8	Unlimited***	2.0	12.7	66.7	50.8	15.9	0.8	9.5	B *	KPS-12-38	28800	M3-5x3
SWFKT-10-D	21715	10	Unlimited***	3.8	15.9	85.7	63.5	22.2	1.5	12.7	D *	KPS-18-50	28805	M3-5x3
SWFKT-12-D	21725	12	Unlimited***	3.8	19.1	92.1	69.9	22.2	1.5	12.7	D *	KPS-18-50	28805	M3-5x3
SWFKT-162-D	21765	16	Unlimited***	3.8	22.2	101.6	76.2	25.4	1.5	15.9	D *	KPS-18-62	28810	M3-5x3
SWFKT-20-M	21735	20	Unlimited***	6.4	31.8	120.7	82.6	38.1	4.8	19.1	M **	KPS-31-75	28840	M3-5x5
SWFKT-25-O	21745	25	Unlimited***	7.1	38.1	139.7	101.6	38.1	4.8	25.4	O **	KPS-31-100	28845	M4-7x8
SWFKT-32-O	21755	32	Unlimited***	7.6	44.5	165.1	127.0	38.1	4.8	31.8	O **	KPS-31-125	28850	M5-8x8
HDSWFKT-20-O	21805	20	Unlimited***	6.6	31.8	120.7	82.6	38.1	4.8	25.4	O **	KPS-31-100-C	28945	M4-7x8
HDSWFKT-25-P	21815	25	Unlimited***	7.6	38.1	149.2	101.6	47.6	5.7	31.8	P **	KPS-50-125-C	28955	M5-8x8
HDSWFKT-32-P	21825	32	Unlimited***	7.6	44.5	171.5	127.0	44.5	5.7	31.8	P **	KPS-50-125-C	28955	M5-8x8

Supplied with one (1) straight high speed beveled TiN coated knurl wheel, *30 TPI (0.8mm), **25 TPI (1.0mm)
*** Warning: May cause deflection on small part diameters, and too much pressure on large diameters

FKT - Fixed Forming Knurling Tool



- Precision square shank with preset center height
- Twin knurl wheels for straight or diamond pattern
- Knurl wheels are mounted between thrust washers to ensure a smooth and even rotation of the knurls

Resulting Knurl Pattern

Straight pattern with straight wheels



Straight

Male 60° diamond pattern with diagonal wheels



Left

Right

Recommended Use:

For best results, use beveled knurl wheels. In-feed the knurling tool into the blank until the right pattern is generated, then end-feed

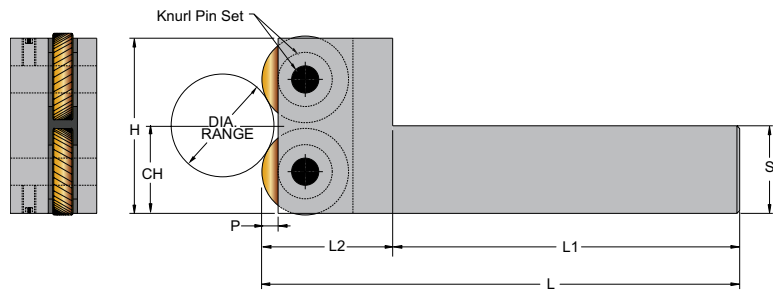

Inch Description	UPC #	CH & S inch	Dia. Range	E	H	L	L1	L2	P	T	Knurl Wheel Series	Knurl Pin Set		Set Screw
												Description	UPC #	
FKT-38-D	21910	0.375	1/4" & up***	0.135	1.000	3.375	2.500	0.875	0.060	0.500	D *	KPS-18-50	28805	M3-.5x3
FKT-50-D	21920	0.500		0.135	1.000	3.625	2.750	0.875	0.060	0.500	D *	KPS-18-50	28805	M3-.5x3
FKT-162-D	21955	0.625		0.135	1.125	4.000	3.000	1.000	0.060	0.625	D *	KPS-18-62	28810	M3-.5x3
FKT-75-M	21930	0.750	5/16" & up***	0.250	2.000	4.750	3.250	1.500	0.190	0.750	M **	KPS-31-75	28840	M4-.7x6
FKT-100-M	21940	1.000		0.250	2.000	5.500	4.000	1.500	0.190	1.000	M **	KPS-31-100	28845	M4-.7x6
FKT-125-O	21950	1.250		0.305	2.500	6.375	5.000	1.375	0.190	1.250	O **	KPS-31-125	28850	M4-.7x6
Metric Description	UPC #	CH & S mm	Dia. Range	E	H	L	L1	L2	P	T	Knurl Wheel Series	Knurl Pin Set		Set Screw No. 1
Description	UPC #	mm										Description	UPC #	
FKT-10-D	21905	10	6.4 & up***	3.4	25.4	85.7	63.5	22.2	1.5	12.7	D *	KPS-18-50	28805	M3-.5x3
FKT-12-D	21915	12		3.4	25.4	92.1	69.9	22.2	1.5	12.7	D *	KPS-18-50	28805	M3-.5x3
FKT-162-D	21955	16		3.4	28.6	101.6	76.2	25.4	1.5	15.9	D *	KPS-18-62	28810	M3-.5x3
FKT-20-M	21925	20	8 & up***	6.4	50.8	120.7	82.6	38.1	4.8	19.1	M **	KPS-31-75	28840	M4-.7x6
FKT-25-M	21935	25		6.4	50.8	139.7	101.6	38.1	4.8	25.4	M **	KPS-31-100	28845	M4-.7x6
FKT-32-O	21945	32		7.7	63.5	161.9	127.0	34.9	4.8	31.8	O **	KPS-31-125	28850	M4-.7x6

Supplied with one (1) set of diagonal high speed beveled TiN coated knurl wheels, *30 TPI, ** 25 TPI
 *** Warning: May cause deflection on small part diameters, and too much pressure on large diameters

Single Shoulder Wheel Fixed Forming Knurling Tool

SSWFKT - Single Shoulder Wheel Fixed Forming Knurling Tool



- Precision square shank with preset center height
- Designed to knurl against a square shoulder
- Single wheel knurling tool for general purposes
- Knurl wheel is mounted on a thrust washer to ensure a smooth and even rotation of the knurl
- Can be reversed for right or left hand operation

Resulting Knurl Pattern

Straight pattern with straight wheel



Straight

Male 60° diamond pattern with female wheel



Female

Recommended Use:

For best results, use beveled knurl wheel. In-feed the knurling tool into the blank until the right pattern is generated, then end-feed for straight pattern. Do not end-feed for diamond pattern.

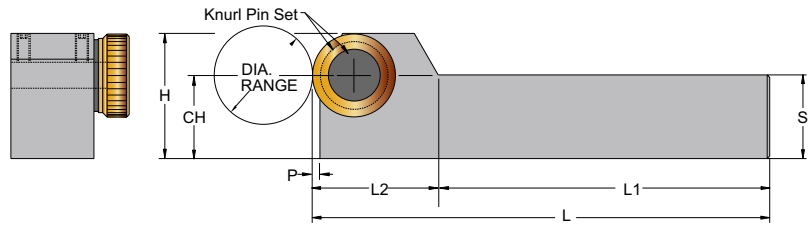
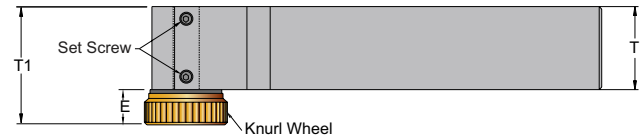

Inch Description	UPC #	CH & S inch	Dia. Range	E	H	L	L1	L2	P	T	T1	Knurl Wheel Series	Knurl Pin Set		Set Screw
													Description	UPC #	
SSWFKT-38-2	21777	0.375	Unlimited***	0.265	0.625	3.125	2.500	0.625	0.050	0.500	0.765	SW2 *	SW2.0P-1S	29050	M3-.5x3
SSWFKT-50-2	21781	0.500	Unlimited***	0.265	0.750	3.375	2.750	0.625	0.050	0.500	0.765	SW2 *	SW2.0P-1S	29050	M3-.5x3
SSWFKT-162-2	21783	0.625	Unlimited***	0.265	0.875	3.625	3.000	0.625	0.050	0.625	0.890	SW2 *	SW2.0P-1S	29050	M3-.5x3
SSWFKT-75-4	21789	0.750	Unlimited***	0.410	1.250	4.500	3.250	1.250	0.050	0.750	1.160	SW4 **	SW4.0P-1S	29080	M4-.7x5
SSWFKT-100-4	21793	1.000	Unlimited***	0.410	1.500	5.250	4.000	1.250	0.050	1.000	1.410	SW4 **	SW4.0P-1S	29080	M4-.7x5
SSWFKT-125-4	21797	1.250	Unlimited***	0.410	1.750	6.250	5.000	1.250	0.050	1.250	1.660	SW4 **	SW4.0P-1S	29080	M5-.8x5
Metric Description	UPC #	CH & S mm	Dia. Range	E	H	L	L1	L2	P	T	T1	Knurl Wheel Series	Knurl Pin Set		Set Screw
SSWFKT-10-2	21775	10	Unlimited***	6.7	15.9	79.4	63.5	15.9	1.3	12.7	19.4	SW2 *	SW2.0P-1S	29050	M3-.5x3
SSWFKT-12-2	21779	12	Unlimited***	6.7	19.1	85.7	69.9	15.9	1.3	12.7	19.4	SW2 *	SW2.0P-1S	29050	M3-.5x3
SSWFKT-162-2	21783	16	Unlimited***	6.7	22.2	92.1	76.2	15.9	1.3	15.9	22.6	SW2 *	SW2.0P-1S	29050	M3-.5x3
SSWFKT-20-4	21787	20	Unlimited***	10.4	31.8	114.3	82.6	31.8	1.3	19.1	29.5	SW4 **	SW4.0P-1S	29080	M4-.7x5
SSWFKT-25-4	21791	25	Unlimited***	10.4	38.1	133.4	101.6	31.8	1.3	25.4	35.8	SW4 **	SW4.0P-1S	29080	M4-.7x5
SSWFKT-32-4	21795	32	Unlimited***	10.4	44.5	158.8	127.0	31.8	1.3	31.8	42.2	SW4 **	SW4.0P-1S	29080	M5-.8x5

Supplied with one (1) beveled straight high speed TiN coated knurl wheel, * 30 TPI (0.8mm), ** 25 TPI (1.00mm)
 *** Warning: May cause deflection on small part diameters, and too much pressure on large diameters

SFKT - Shoulder Fixed Forming Knurling Tool



- Precision square shank with preset center height
- Designed to knurl against a square shoulder
- Twin knurl wheels for straight or diamond pattern
- Knurl wheels are mounted on a thrust washer to ensure a smooth and even rotation of the knurl
- Can be reversed for right or left hand operation



Resulting Knurl Pattern

Straight pattern with straight wheels



Straight

Male 60° diamond pattern with diagonal wheels



Left

Right

Recommended Use:

For best results, use beveled knurl wheels. In-feed the knurling tool into the blank until the right pattern is generated, then end-feed.

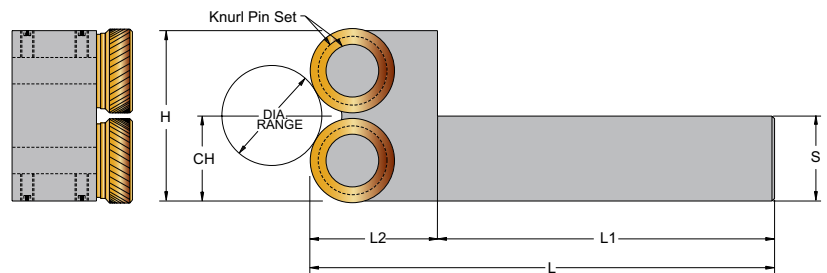
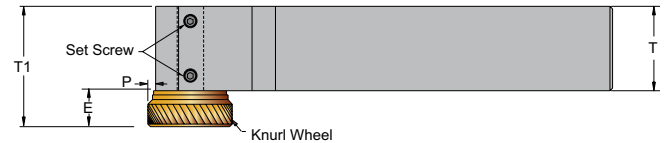

Inch Description	UPC #	CH & S inch	Dia. Range	E	H	L	L1	L2	P	T	T1	Knurl Wheel Series	Knurl Pin Set		
													Description	UPC #	Set Screw
SFKT-38-2	22010	0.375	1/4" & up***	0.265	1.000	3.125	2.500	0.625	0.050	0.500	0.765	SW2 *	SW2.0P-2S	29055	M3-.5x3
SFKT-50-2	22020	0.500		0.265	1.000	3.375	2.750	0.625	0.050	0.500	0.765	SW2 *	SW2.0P-2S	29055	M3-.5x3
SFKT-162-2	22055	0.625		0.265	1.125	4.000	3.250	0.750	0.050	0.625	0.890	SW2 *	SW2.0P-2S	29055	M3-.5x3
SFKT-75-4	22030	0.750	5/16" & up***	0.410	2.000	4.375	3.250	1.125	0.050	0.750	1.160	SW4 **	SW4.0P-2S	29085	M5-.8x5
SFKT-100-4	22040	1.000		0.410	2.000	5.125	4.000	1.125	0.050	1.000	1.410	SW4 **	SW4.0P-2S	29085	M5-.8x5
SFKT-125-4	22050	1.250		0.410	2.500	6.375	5.000	1.375	0.050	1.250	1.660	SW4 **	SW4.0P-2S	29085	M5-.8x8
Metric Description	UPC #	CH & S mm	Dia. Range	E	H	L	L1	L2	P	T	T1	Knurl Wheel Series	Knurl Pin Set		
SFKT-10-2	22005	10	6,4mm & up***	6.7	25.4	79.4	63.5	15.9	1.3	12.7	19.4	SW2 *	SW2.0P-2S	29055	M3-.5x3
SFKT-12-2	22015	12		6.7	25.4	85.7	69.9	15.9	1.3	12.7	19.4	SW2 *	SW2.0P-2S	29055	M3-.5x3
SFKT-162-2	22055	16		6.7	28.6	101.6	82.6	19.1	1.3	19.1	22.6	SW2 *	SW2.0P-2S	29055	M3-.5x3
SFKT-20-4	22025	20	8mm & up***	10.4	50.8	111.1	82.6	28.6	1.3	19.1	29.5	SW4 **	SW4.0P-2S	29085	M5-.8x5
SFKT-25-4	22035	25		10.4	50.8	130.2	101.6	28.6	1.3	25.4	35.8	SW4 **	SW4.0P-2S	29085	M5-.8x5
SFKT-32-4	22045	32		10.4	63.5	161.9	127.0	34.9	1.3	31.8	42.2	SW4 **	SW4.0P-2S	29085	M5-.8x8

Supplied with one (1) set of beveled diagonal high speed TiN coated knurl wheels, * 30 TPI (0.8mm), ** 25 TPI (1.0mm)
 *** Warning: May cause deflections on small part diameters, and too much pressure on large diameters

Internal Forming Knurling Tool

TIKT - True Internal Forming Knurling Tool



- For true internal knurling requiring a straight or diamond pattern
- True internal knurling is used to reduce oversized internal diameters or for specific knurling applications
- Knurl wheel is mounted between thrust washers to ensure a smooth and even rotation of the knurl
- Single wheel knurling tool

Resulting Knurl Pattern

Straight pattern with straight wheel



Straight

Male 60° diamond pattern with female wheel



Female

Recommended Use:

For best results, use beveled knurl wheel. In-feed the knurling tool into the blank until the right pattern is generated, then end-feed for straight pattern. Do not end-feed for diamond pattern.

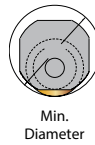

Min. Diameter

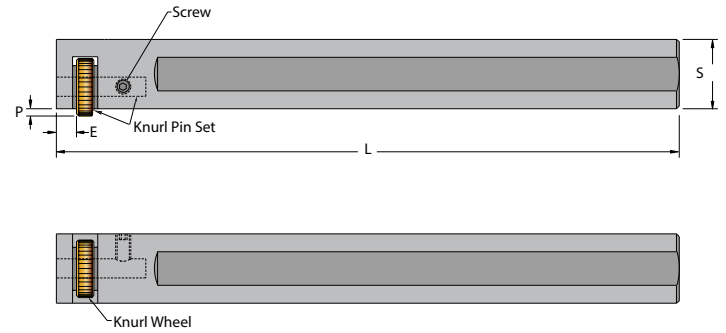

Inch		S inch	Min. Diameter	E	L	P	Knurl Wheel Series	Knurl Pin Set		Set Screw
Description	UPC #							Description	UPC #	
TIKT-50-B	22611	0.500	0.562"	0.100	4.000	0.030	B *	KPS-12-38	28800	M3-.5x5
TIKT-75-D	22621	0.750	1.000"	0.115	6.125	0.060	D *	KPS-18-50	28805	M3-.5x5
TIKT-100-R	22631	1.000	1.190"	0.170	8.000	0.090	R **	KPS-25-75	28820	M4-.7x8
TIKT-125-M	22641	1.250	1.500"	0.190	10.000	0.110	M **	KPS-31-100	28845	M4-.7x8
Metric		S mm	Min. Diameter	E	L	P	Knurl Wheel Series	Knurl Pin Set		Set Screw
Description	UPC #							Description	UPC #	
TIKT-12-B	22601	12	14.3mm	2.5	101.6	0.8	B *	KPS-12-38	28800	M3-.5x5
TIKT-20-D	22616	20	25.4mm	2.9	155.6	1.5	D *	KPS-18-50	28805	M3-.5x5
TIKT-25-R	22626	25	30.2mm	4.3	203.2	2.3	R **	KPS-25-75	28820	M4-.7x8
TIKT-32-M	22636	32	38.1mm	4.8	254.0	2.8	M **	KPS-31-100	28845	M4-.7x8

Supplied with one (1) beveled straight high speed TiN coated knurl wheel, *30 TPI (0.8mm), **25 TPI (1.0mm)

SIKT - Shoulder Internal Forming Knurling Tool



- For internal knurling requiring a straight or diamond pattern
- Designed to knurl against a square shoulder
- Internal knurling is used to reduce oversized internal diameters or for specific knurling applications
- Knurl wheel is mounted on a thrust washer to ensure a smooth and even rotation of the knurl
- Single wheel knurling tool

Resulting Knurl Pattern

Straight pattern with straight wheel



Straight

Male 60° diamond pattern with female wheel



Female

Recommended Use:

For best results, use beveled knurl wheel. In-feed the knurling tool into the blank until the right pattern is generated, then end-feed for straight pattern. Do not end-feed for diamond pattern.

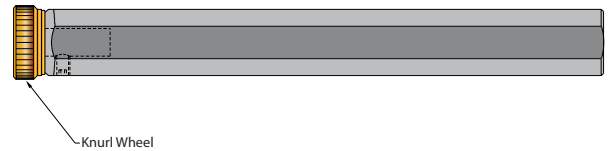
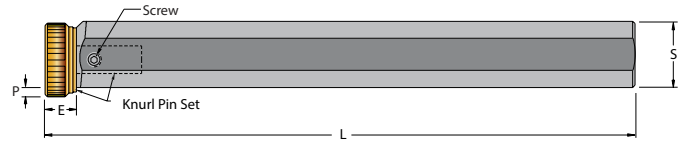
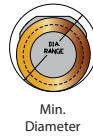

Inch Description	UPC #	S inch	Min. Diameter	E	L	P	Knurl Wheel Series	Knurl Pin Set		
								Description	UPC #	Set Screw
SIKT-50-2	22610	0.500	0.562"	0.265	4.000	0.050	SW2 *	SW2.0P-1S	29050	M4-.7x4
SIKT-75-4	22620	0.750	1.125"	0.410	6.125	0.050	SW4 **	SW4.0P-1S	29080	M5-.8x5
SIKT-100-4	22630	1.000	1.125"	0.410	8.000	0.050	SW4 **	SW4.0P-1S	29080	M5-.8x5
SIKT-125-4	22640	1.250	1.375"	0.410	10.000	0.050	SW4 **	SW4.0P-1S	29080	M5-.8x5
Metric Description	UPC #	S mm	Min. Diameter	E	L	P	Knurl Wheel Series	Knurl Pin Set		
SIKT-12-2	22605	12	14.3mm	6.7	101.6	1.3	SW2 *	SW2.0P-1S	29050	M4-.7x4
SIKT-20-4	22615	20	28.6mm	10.4	155.6	1.3	SW4 **	SW4.0P-1S	29080	M5-.8x5
SIKT-25-4	22625	25	28.6mm	10.4	203.2	1.3	SW4 **	SW4.0P-1S	29080	M5-.8x5
SIKT-32-4	22635	32	35.0mm	10.4	254.0	1.3	SW4 **	SW4.0P-1S	29080	M5-.8x5

Supplied with one (1) beveled straight high speed TiN coated knurl wheel, * 30 TPI (0.8mm), ** 25 TPI (1mm)

Milling Machine Forming Knurling Tool

MMKT - Milling Machine Forming Knurling Tool



- Specifically designed to knurl a flat surface
- Tool has been engineered to be used on milling machines
- Ground Weldon shank to fit in the milling holders
- Knurl wheel is mounted between thrust washers to ensure a smooth and even rotation of the knurl
- Single wheel knurling tool

Resulting Knurl Pattern

Straight pattern with straight wheel Male 60° diamond pattern with female wheel Female 60° diamond pattern with male wheel



Straight



Female



Male

Recommended Use:

For best results, use beveled knurl wheel. In-feed the knurling tool into the blank until the right pattern is generated, then end-feed.

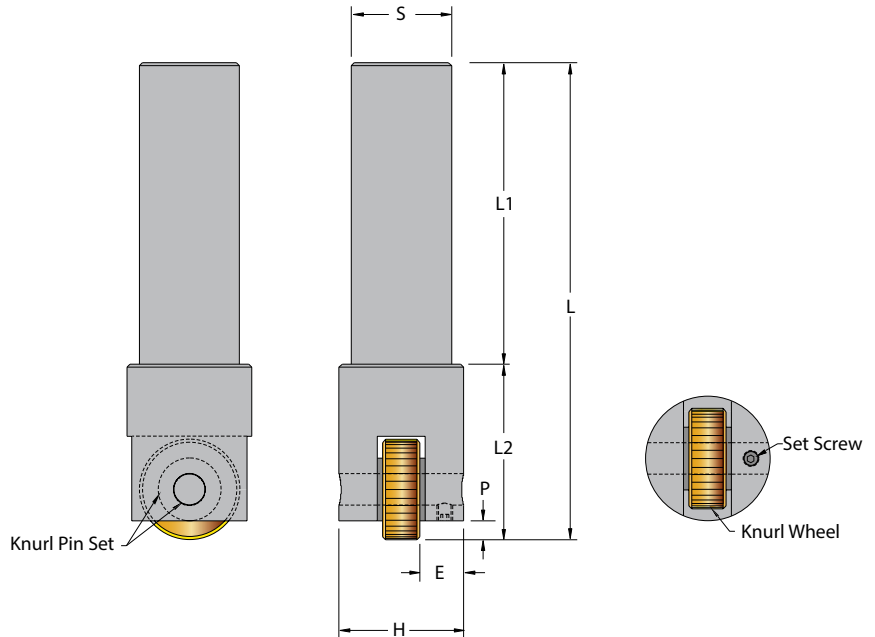

Inch Description	UPC #	S inch	E	H	L	L1	L2	P	Knurl Wheel Series	Knurl Pin Set		Set Screw
										Description	UPC #	
MMKT-38-D	22510	0.375	0.235	0.625	2.375	1.500	0.875	0.060	D *	KPS-18-62	28810	M3-.5x3
MMKT-50-R	22520	0.500	0.340	0.875	3.125	2.000	1.125	0.100	R **	KPS-25-87	28825	M3-.5x4
MMKT-75-O	22530	0.750	0.312	1.000	4.000	2.500	1.500	0.190	O **	KPS-31-100	28845	M3-.5x4
MMKT-100-O	22540	1.000	0.437	1.250	4.750	3.000	1.750	0.190	O **	KPS-31-125	28850	M4-.7x4
MMKT-125-P	22550	1.250	0.500	1.500	5.625	3.500	2.125	0.125	P **	KPS-50-150	28860	M4-.7x6
Metric Description	UPC #	S mm	E	H	L	L1	L2	P	Knurl Wheel Series	Knurl Pin Set		Set Screw
MMKT-10-D	22505	10	6.0	15.9	60.3	38.1	22.2	1.5	D *	KPS-18-62	28810	M3-.5x3
MMKT-12-R	22515	12	8.6	22.2	79.4	50.8	28.6	2.5	R **	KPS-25-87	28825	M3-.5x4
MMKT-20-O	22525	20	7.9	25.4	101.6	63.5	38.1	4.8	O **	KPS-31-100	28845	M3-.5x4
MMKT-25-O	22535	25	11.1	31.8	120.7	76.2	44.5	4.8	O **	KPS-31-125	28850	M4-.7x4
MMKT-32-P	22545	32	12.7	38.1	142.9	88.9	54.0	3.2	P **	KPS-50-150	28860	M4-.7x6

Supplied with one (1) beveled straight high speed TiN coated knurl wheel, *30 TPI (0.8mm), **25 TPI (1.0mm)

Diametral Forming Knurling Tools A diametral adjustment screw regulates the depth of the knurl pattern and the diameter size. The floating head will allow the knurl wheel to self adjust on the work piece - even when the work piece is not perfectly concentric. However, the tool can be used for twin wheel applications or single wheel knurling applications. This tool comes with a square shank to be used on open slot tool holders, or on a square index turret, with a preset center height adjustment which will meet the fixed center height of the CNC and the turret lathe. Body and shank are made of heat-treated, precision ground alloy steel. The dovetail guide ensures the most precise accuracy and rigidity for infinite diameter settings.

Heavy Duty Style Forming Knurling Tool

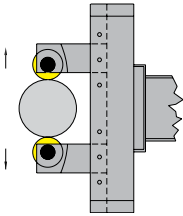

Straddle application is best when pressure and deflection are a problem. The knurling arms are able to "float" somewhat and center on the workpiece, compensating for any off-centering. It has been developed to make a perfect knurling pattern without putting any pressure on the spindle or on the lathe compound.

Uses 2 wheels
for straight pattern

Uses 2 wheels
for 60° diamond pattern
1 Diag. Lt.
1 Diag. Rt.

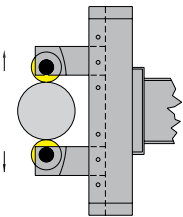

Bump application is best for narrow knurling applications. The knurling arms are moved closer together so that the tool can "bump" against the side of the working part with two wheels touching the part.

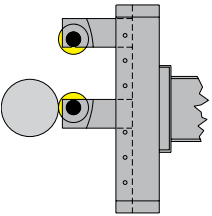

Single wheel application is best for narrow and quick knurling setup. The knurling arms are moved up so that the bottom knurling wheel is locked on center and can "bump" against the side of the working part. With one wheel touching the part, this configuration allows for a quicker setup and knurling of narrow knurling applications.



Knurl wheels are supported in a flanged nest to offer best rigidity to handle heavy duty knurling. The knurl wheels are mounted between thrust washers to insure a smooth and even rotation while knurling is performed.

Shoulder Style Forming Knurling Tool

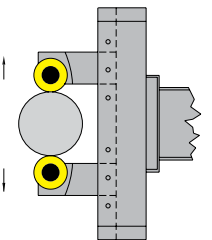

Straddle application is best when pressure and deflection are a problem. The knurling arms are able to "float" somewhat and center on the workpiece, compensating for any off-centering. It has been developed to make a perfect knurling pattern without putting any pressure on the spindle or on the lathe compound.

Uses 2 wheels
for straight pattern

Uses 2 wheels
for 60° diamond pattern
1 Diag. Lt.
1 Diag. Rt.

Designed to knurl against a square shoulder. The knurl wheels are mounted on a thrust washer to insure a smooth and even rotation while knurling is performed. The wheels are held at slight pitch to the work part for better end feeding (feeding across the part towards the chuck).

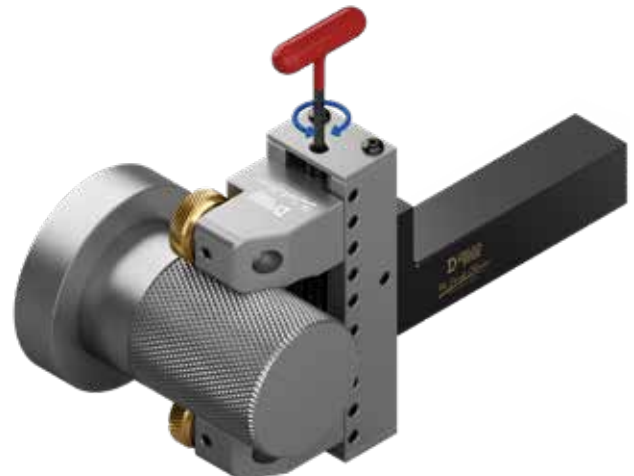

Diametral Forming Knurling Tools

KTM109 Heavy Duty Style Straddle Square Shank Knurling Tool



- Precision square shank with preset center height
- Adjustable heavy duty arms for precise workpiece diameter setting
- Can be reversed for right or left hand operation
- Knurl wheels are mounted between thrust washers to ensure a smooth and even rotation of the knurls
- Twin knurl wheels for straight or diamond pattern



1.5" & 2.5"
(38mm & 63.5mm)
Diameter Range

Resulting Knurl Pattern

Straight pattern
with straight wheels



Straight

Male 60° diamond pattern
with diagonal wheels



Left

Right

Recommended Use:

For best results, use beveled knurl wheels. In-feed the knurling tool into the blank until the right pattern is generated, then end-feed.

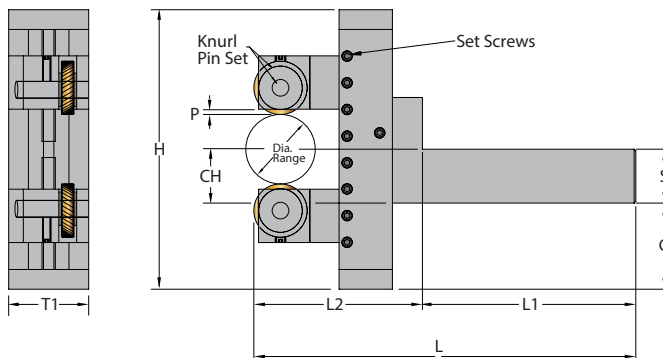
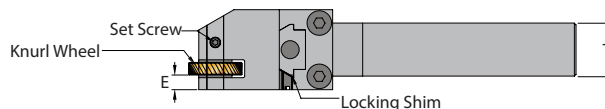

Inch Description	UPC #	CH & S inch	Dia. Range	E	G	H	L	L1	L2	P	T	T1	Knurl Wheel Series	Knurl Arm Set **		Set Screw
														Supplied	Optional	
1.5" Max. Diameter Range																
KTM109-75-15-M	22814	0.750	0 - 1.50" ***	0.250	1.250	4.000	6.625	3.250	3.375	0.188	1.000	1.500	M*	W109-3-25-M	W109-3-25-4	M5-8x5
KTM109-100-15-M	22816	1.000		0.250	1.000	4.000	7.375	4.000	3.375	0.188	1.000	1.500	M*	W109-3-25-M	W109-3-25-4	M5-8x5
KTM109-125-15-M	22818	1.250		0.250	0.750	4.000	8.375	5.000	3.375	0.188	1.250	1.500	M*	W109-3-25-M	W109-3-25-4	M5-8x5
2.5" Max. Diameter Range																
KTM109-75-25-M	22823	0.750	.125-2.50" ***	0.250	1.688	4.875	6.625	3.250	3.375	0.188	1.00	1.50	M*	W109-3-25-M	W109-3-25-4	M5-8x5
KTM109-100-25-M	22824	1.000		0.250	1.437	4.875	7.375	4.000	3.375	0.188	1.00	1.50	M*	W109-3-25-M	W109-3-25-4	M5-8x5
KTM109-125-25-M	22826	1.250		0.250	1.188	4.875	8.375	5.000	3.375	0.188	1.25	1.50	M*	W109-3-25-M	W109-3-25-4	M5-8x5
Metric																
Metric Description	UPC #	CH & S mm	Dia. Range	E	G	H	L	L1	L2	P	T	T1	Knurl Wheel Series	Knurl Arm Set **		Set Screw
38mm Max. Diameter Range																
KTM109-20-15-M	22811	20	0 - 38mm***	6.4	31.8	101.6	168.3	82.6	85.7	4.8	25.4	38.1	M*	W109-3-25-M	W109-3-25-4	M5-8x5
KTM109-25-15-M	22812	25		6.4	25.4	101.6	187.3	101.6	85.7	4.8	25.4	38.1	M*	W109-3-25-M	W109-3-25-4	M5-8x5
KTM109-32-15-M	22813	32		6.4	19.1	101.6	212.7	127.0	85.7	4.8	31.8	38.1	M*	W109-3-25-M	W109-3-25-4	M5-8x5
63mm Max. Diameter Range																
KTM109-20-25-M	22819	20	32-63mm***	6.4	42.9	123.8	168.3	82.6	85.7	4.8	25.4	38.1	M*	W109-3-25-M	W109-3-25-4	M5-8x5
KTM109-25-25-M	22821	25		6.4	36.5	123.8	187.3	101.6	85.7	4.8	25.4	38.1	M*	W109-3-25-M	W109-3-25-4	M5-8x5
KTM109-32-25-M	22822	32		6.4	30.2	123.8	212.7	127.0	85.7	4.8	31.8	38.1	M*	W109-3-25-M	W109-3-25-4	M5-8x5

* Supplied with one (1) set of beveled diagonal high speed TiN coated knurl wheels for a male diamond pattern, 25 TPI (1.00mm)

** See Page H-54 for optional arms and specifications

***Warning: This tool has the capability to adjust the wheels until they touch, but physically applying a knurl on small diameters may not be possible

KTW109 Shoulder Style Straddle Square Shank Forming Knurling Tool



- Precision square shank with preset center height
- Adjustable heavy duty arms for precise workpiece diameter setting
- Can be reversed for right or left hand operation
- Knurl wheels are mounted between thrust washers to ensure a smooth and even rotation of the knurls
- Twin knurl wheels for straight or diamond pattern to a shoulder

Resulting Knurl Pattern

Straight pattern with straight wheels



Straight

Male 60° diamond pattern with diagonal wheels



Left



Right

Recommended Use:

For best results, use beveled knurl wheels. In-feed the knurling tool into the blank until the right pattern is generated, then end-feed.

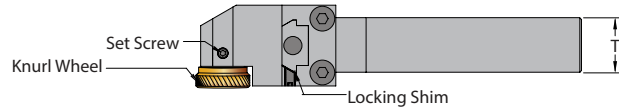

1.5" & 2.5"
(38mm & 63,5mm)
Diameter Range

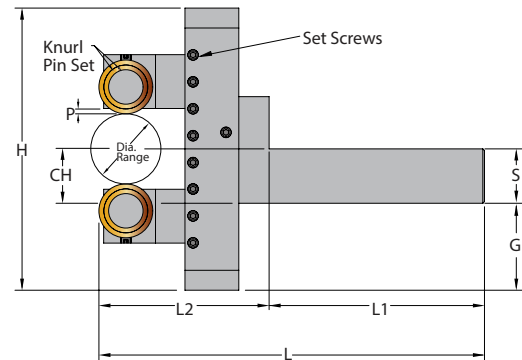
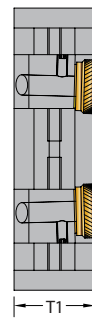

Inch Description	UPC #	CH & S inch	Dia. Range	G	H	L	L1	L2	P	T	T1	Knurl Wheel Series	Knurl Arm Set **		Set Screw
													Supplied	Optional	
1.5" Max. Diameter Range															
KTW109-75-15-4	22832	0.750	0-1.50***	1.250	4.000	6.625	3.250	3.375	0.050	1.000	1.500	SW4*	W109-3-25-4	W109-3-25-M	M5-.8x5
KTW109-100-15-4	22833	1.000		1.000	4.000	7.375	4.000	3.375	0.050	1.000	1.500	SW4*	W109-3-25-4	W109-3-25-M	M5-.8x5
KTW109-125-15-4	22834	1.250		0.750	4.000	8.375	5.000	3.375	0.050	1.250	1.500	SW4*	W109-3-25-4	W109-3-25-M	M5-.8x5
2.5" Max. Diameter Range															
KTW109-75-25-4	22841	0.750	.125-2.50***	1.688	4.875	6.625	3.250	3.375	0.050	1.00	1.50	SW4*	W109-3-25-M	W109-3-25-4	M5-.8x5
KTW109-100-25-4	22842	1.000		1.437	4.875	7.375	4.000	3.375	0.050	1.00	1.50	SW4*	W109-3-25-M	W109-3-25-4	M5-.8x5
KTW109-125-25-4	22843	1.250		1.188	4.875	8.375	5.000	3.375	0.050	1.25	1.50	SW4*	W109-3-25-M	W109-3-25-4	M5-.8x5
Metric Description	UPC #	CH & S mm	Dia. Range	G	H	L	L1	L2	P	T	T1	Knurl Wheel Series	Knurl Arm Set **		Set Screw
38mm Max. Diameter Range															
KTW109-20-15-4	22828	20	0-38mm***	31.8	101.6	168.3	82.6	85.7	1.3	25.4	38.1	SW4*	W109-3-25-4	W109-3-25-M	M5-.8x5
KTW109-25-15-4	22829	25		25.4	101.6	187.3	101.6	85.7	1.3	25.4	38.1	SW4*	W109-3-25-4	W109-3-25-M	M5-.8x5
KTW109-32-15-4	22831	32		19.1	101.6	212.7	127.0	85.7	1.3	31.8	38.1	SW4*	W109-3-25-4	W109-3-25-M	M5-.8x5
63mm Max. Diameter Range															
KTW109-20-25-4	22836	20	3.2-63mm***	2580.6	4274.8	2098.0	2176.8	2176.8	33.0	645.1	807.7	SW4*	W109-3-25-4	W109-3-25-M	M5-.8x5
KTW109-25-25-4	22838	25		2580.6	4757.4	2580.6	2176.8	2176.8	33.0	645.1	807.7	SW4*	W109-3-25-4	W109-3-25-M	M5-.8x5
KTW109-32-25-4	22839	32		2580.6	5402.5	3225.8	2176.8	2176.8	33.0	807.7	807.7	SW4*	W109-3-25-4	W109-3-25-M	M5-.8x5

* Supplied with one (1) set of beveled diagonal high speed TiN coated knurl wheels for a male diamond pattern, 25 TPI (1.00mm)

** See Page H-54 for optional arms and specifications

***Warning: This tool has the capability to adjust the wheels until they touch, but physically applying a knurl on small diameters may not be possible

Diametral Forming Knurling Tools

KTO109-40 Heavy Duty Style Straddle Square Shank Knurling Tool



- Precision square shank with preset center height
- Adjustable heavy duty arms for precise workpiece diameter setting
- Can be reversed for right or left hand operation
- Knurl wheels are mounted between thrust washers to ensure a smooth and even rotation of the knurls
- Twin knurl wheels for straight or diamond pattern

Resulting Knurl Pattern

Straight pattern with straight wheels



Straight

Male 60° diamond pattern with diagonal wheels



Left



Right

Recommended Use:

For best results, use beveled knurl wheels. In-feed the knurling tool into the blank until the right pattern is generated, then end-feed.



4.0"
(100mm)
Diameter Range

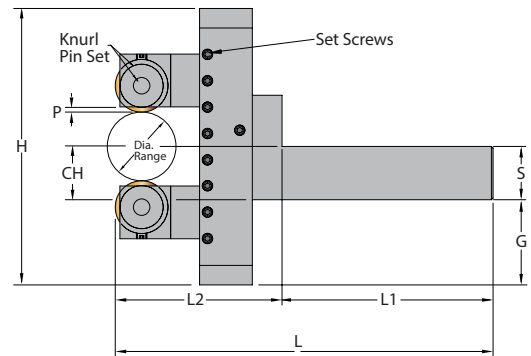
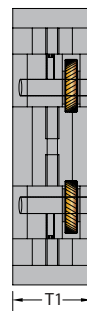
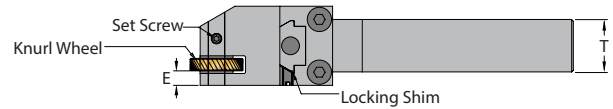

Inch Description	UPC #	CH & S inch	Dia. Range	E	G	H	L	L1	L2	P	T	T1	Knurl Wheel Series	Knurl Arm Set **		Set Screw
														Supplied	Optional	
4.0" Max. Diameter Range																
KTO109-100-40-O	22869	1.000	.63-4.00***	0.250	2.174	6.347	9.875	5.000	4.875	0.188	1.25	2.00	O*	W109-3-40-O	W109-3-40-4	M5-.8x6
KTO109-125-40-O	22870	1.250		0.250	1.924	6.347	9.875	5.000	4.875	0.188	1.25	2.00	O*	W109-3-40-O	W109-3-40-4	M5-.8x6
Metric																
Description	UPC #	CH & S mm	Dia. Range	E	G	H	L	L1	L2	P	T	T1	Knurl Wheel Series	Knurl Arm Set **		Set Screw
														Supplied	Optional	
100mm Max. Diameter Range																
KTO109-25-40-O	22867	25	16-100mm***	6.4	55.2	161.2	250.8	127.0	123.8	4.8	31.8	50.8	O*	W109-3-40-O	W109-3-40-4	M5-.8x6
KTO109-32-40-O	22868	32		6.4	48.9	161.2	250.8	127.0	123.8	4.8	31.8	50.8	O*	W109-3-40-O	W109-3-40-4	M5-.8x6

* Supplied with one (1) set of beveled diagonal high speed TiN coated knurl wheels for a male diamond pattern, 25 TPI (1.00mm)

** See Page H-54 for optional arms and specifications

***Warning: Physically applying a knurl on small diameters may not be possible

KTW109-40 Shoulder Style Straddle Square Shank Knurling Tool



- Precision square shank with preset center height
- Adjustable heavy duty arms for precise workpiece diameter setting
- Can be reversed for right or left hand operation
- Knurl wheels are mounted between thrust washers to ensure a smooth and even rotation of the knurls
- Twin knurl wheels for straight or diamond pattern to a shoulder

Resulting Knurl Pattern

Straight pattern with straight wheels



Straight

Male 60° diamond pattern with diagonal wheels



Left

Right

Recommended Use:

For best results, use beveled knurl wheels. In-feed the knurling tool into the blank until the right pattern is generated, then end-feed.

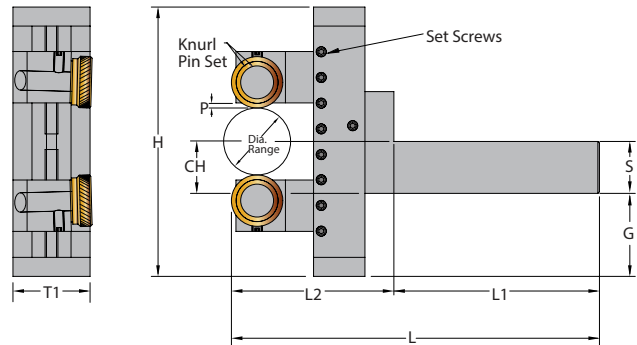
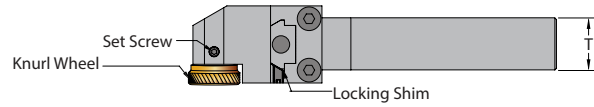

Inch Description	UPC #	CH & S inch	Dia. Range	G	H	L	L1	L2	P	T	T1	Knurl Wheel Series	Knurl Arm Set **		Set Screw
													Supplied	Optional	
4.0" Max. Diameter Range															
KTW109-100-40-4	22873	1.000	.63-4.00***	2.174	6.347	9.875	5.000	4.875	0.050	1.250	2.000	SW4*	W109-3-40-4	W109-3-40-O	M5-.8x6
KTW109-125-40-4	22874	1.250		1.924	6.347	9.875	5.000	4.875	0.050	1.250	2.000	SW4*	W109-3-40-4	W109-3-40-O	M5-.8x6
Metric															
Metric Description	UPC #	CH & S mm	Dia. Range	G	H	L	L1	L2	P	T	T1	Knurl Wheel Series	Knurl Arm Set **		Set Screw
100mm Max. Diameter Range															
KTW109-25-40-4	22871	25	16-100mm	55.2	161.2	250.8	127.0	123.8	1.3	31.8	50.8	SW4*	W109-3-40-4	W109-3-40-O	M5-.8x6
KTW109-32-40-4	22872	32	***	48.9	161.2	250.8	127.0	123.8	1.3	31.8	50.8	SW4*	W109-3-40-4	W109-3-40-O	M5-.8x6

* Supplied with one (1) set of beveled diagonal high speed TiN coated knurl wheels for a male diamond pattern, 25 TPI (1.00mm)

** See Page H-54 for optional arms and specifications

***Warning: Physically applying a knurl on small diameters may not be possible

Diametral Forming Knurling Tools

CNC109-M Side Mount Flange Style Square Shank Knurling Tool



- Precision square shank with preset center height is offset to the side of the tool to allow for better indexing clearance on CNC Machines
- Adjustable heavy duty arms for precise workpiece diameter setting
- Can be reversed for right or left hand operation
- Knurl wheels are mounted between thrust washers to ensure a smooth and even rotation of the knurls
- Twin knurl wheels for straight or diamond pattern



Resulting Knurl Pattern

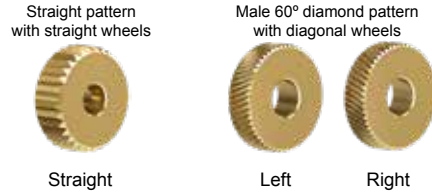

Recommended Use:

For best results, use beveled knurl wheels. In-feed the knurling tool into the blank until the right pattern is generated, then end-feed.

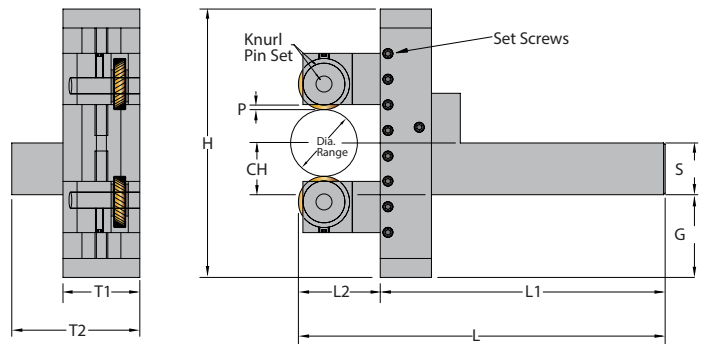
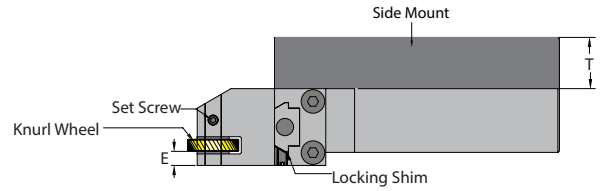

Inch Description	UPC #		CH & S inch	Dia. Range	E	G	H	L	L1	L2	P	T	T1	T2	Knurl Wheel Series	Knurl Arm Set **		Set Screw
	R.H.	L.H.														Supplied	Optional	
1.5" Max. Diameter Range																		
CNC109-75-15-M-R/L	21449	21452	0.750	0-1.50"***	0.250	1.250	4.000	6.062	4.250	1.812	0.188	1.000	1.500	2.500	M*	W109-3-25-M	W109-3-25-4	M5-.8x5
CNC109-100-15-M-R/L	21450	21453	1.000		0.250	1.000	4.000	6.812	5.000	1.812	0.188	1.000	1.500	2.500	M*	W109-3-25-M	W109-3-25-4	M5-.8x5
CNC109-125-15-M-R/L	21451	21454	1.250		0.250	0.750	4.000	6.812	5.000	1.812	0.188	1.250	1.500	2.750	M*	W109-3-25-M	W109-3-25-4	M5-.8x5
2.5" Max. Diameter Range																		
CNC109-75-25-M-R/L	21461	21464	0.750	.125-2.50"***	0.250	1.688	4.875	6.062	4.250	1.812	0.188	1.000	1.500	2.500	M*	W109-3-25-M	W109-3-25-4	M5-.8x5
CNC109-100-25-M-R/L	21462	21465	1.000		0.250	1.437	4.875	6.812	5.000	1.812	0.188	1.000	1.500	2.500	M*	W109-3-25-M	W109-3-25-4	M5-.8x5
CNC109-125-25-M-R/L	21463	21466	1.250		0.250	1.188	4.875	6.812	5.000	1.812	0.188	1.250	1.500	2.750	M*	W109-3-25-M	W109-3-25-4	M5-.8x5
Metric Description	UPC #		CH & S mm	Dia. Range	E	G	H	L	L1	L2	P	T	T1	T2	Knurl Wheel Series	Knurl Arm Set **		Set Screw
R.H.	L.H.	Supplied														Optional		
38mm Max. Diameter Range																		
CNC109-20-15-M-R/L	21443	21446	20	0-38mm***	6.4	31.8	101.6	154.0	108.0	46.0	4.8	25.4	38.1	63.5	M*	W109-3-25-M	W109-3-25-4	M5-.8x5
CNC109-25-15-M-R/L	21444	21447	25		6.4	25.4	101.6	173.0	127.0	46.0	4.8	25.4	38.1	63.5	M*	W109-3-25-M	W109-3-25-4	M5-.8x5
CNC109-32-15-M-R/L	21445	21448	32		6.4	19.1	101.6	173.0	127.0	46.0	4.8	31.8	38.1	69.9	M*	W109-3-25-M	W109-3-25-4	M5-.8x5
63mm Max. Diameter Range																		
CNC109-20-25-M-R/L	21455	21458	20	32-63.5mm***	6.4	42.9	123.8	154.0	108.0	46.0	4.8	25.4	38.1	63.5	M*	W109-3-25-M	W109-3-25-4	M5-.8x5
CNC109-25-25-M-R/L	21456	21459	25		6.4	36.5	123.8	173.0	127.0	46.0	4.8	25.4	38.1	63.5	M*	W109-3-25-M	W109-3-25-4	M5-.8x5
CNC109-32-25-M-R/L	21457	21460	32		6.4	30.2	123.8	173.0	127.0	46.0	4.8	31.8	38.1	69.9	M*	W109-3-25-M	W109-3-25-4	M5-.8x5

* Supplied with one (1) set of beveled diagonal high speed TiN coated knurl wheels, 25 TPI (1.00mm)

* See Page H-54 for optional arms and specifications

*** Warning: This tool has the capability to adjust the wheels until they touch, but physically applying a knurl on small diameters may not be possible

CNC109-4 Side Mount Shoulder Style Square Shank Knurling Tool



- Precision square shank with preset center height is offset to the side of the tool to allow for better indexing clearance on CNC Machines
- Adjustable heavy duty arms for precise workpiece diameter setting
- Can be reversed for right or left hand operation
- Knurl wheels are mounted between thrust washers to ensure a smooth and even rotation of the knurls
- Twin knurl wheels for straight or diamond pattern to a shoulder



1.5" & 2.5"
(38,1mm & 63,5mm)
Diameter Range

Resulting Knurl Pattern

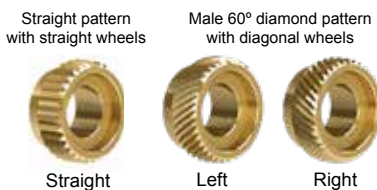

Recommended Use:

For best results, use beveled knurl wheels. In-feed the knurling tool into the blank until the right pattern is generated, then end-feed.

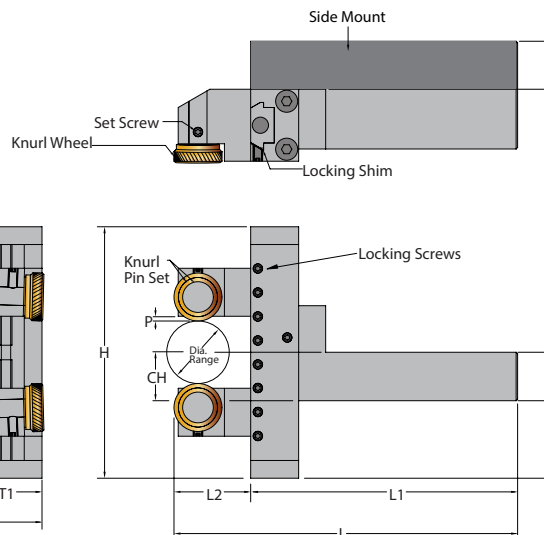

Inch Description	UPC #		CH & S inch	Dia. Range	G	H	L	L1	L2	P	T	T1	T2	Knurl Wheel Series	Knurl Arm Set **		Set Screw
	R.H.	L.H.													Supplied	Optional	
1.5" Max. Diameter Range																	
CNC109-75-15-4-R/L	21473	21476	0.750	0-1.50" ***	1.250	4.000	6.062	4.250	1.812	0.050	1.000	1.500	2.500	SW4*	W109-3-25-4	W109-3-25-M	M5-.8x5
CNC109-100-15-4-R/L	21474	21477	1.000		1.000	4.000	6.812	5.000	1.812	0.050	1.000	1.500	2.500	SW4*	W109-3-25-4	W109-3-25-M	M5-.8x5
CNC109-125-15-4-R/L	21475	21478	1.250		0.750	4.000	6.812	5.000	1.812	0.050	1.250	1.500	2.750	SW4*	W109-3-25-4	W109-3-25-M	M5-.8x5
2.5" Max. Diameter Range																	
CNC109-75-25-4-R/L	21485	21488	0.750	.125-2.50" ***	1.688	4.875	6.062	4.250	1.812	0.050	1.00	1.500	2.50	SW4*	W109-3-25-4	W109-3-25-M	M5-.8x5
CNC109-100-25-4-R/L	21486	21489	1.000		1.437	4.875	6.812	5.000	1.812	0.050	1.00	1.500	2.50	SW4*	W109-3-25-4	W109-3-25-M	M5-.8x5
CNC109-125-25-4-R/L	21487	21490	1.250		1.188	4.875	6.812	5.000	1.812	0.050	1.25	1.500	2.75	SW4*	W109-3-25-4	W109-3-25-M	M5-.8x5
Metric Description	UPC #		CH & S mm	Dia. Range	G	H	L	L1	L2	P	T	T1	T2	Knurl Wheel Series	Knurl Arm Set **		Set Screw
R.H.	L.H.	Supplied													Optional		
38mm Max. Diameter Range																	
CNC109-20-15-4-R/L	21467	21470	20	0-38mm***	31.8	101.6	154.0	108.0	46.0	1.3	25.4	38.1	63.5	SW4*	W109-3-25-4	W109-3-25-M	M5-.8x5
CNC109-25-15-4-R/L	21468	21471	25		25.4	101.6	173.0	127.0	46.0	1.3	25.4	38.1	63.5	SW4*	W109-3-25-4	W109-3-25-M	M5-.8x5
CNC109-32-15-4-R/L	21469	21472	32		19.1	101.6	173.0	127.0	46.0	1.3	31.8	38.1	69.9	SW4*	W109-3-25-4	W109-3-25-M	M5-.8x5
63mm Max. Diameter Range																	
CNC109-20-25-4-R/L	21479	21482	20	3.2-63.5mm***	42.9	123.8	154.0	108.0	46.0	1.3	25.4	38.1	63.5	SW4*	W109-3-25-4	W109-3-25-M	M5-.8x5
CNC109-25-25-4-R/L	21480	21483	25		36.5	123.8	173.0	127.0	46.0	1.3	25.4	38.1	63.5	SW4*	W109-3-25-4	W109-3-25-M	M5-.8x5
CNC109-32-25-4-R/L	21481	21484	32		30.2	123.8	173.0	127.0	46.0	1.3	31.8	38.1	69.9	SW4*	W109-3-25-4	W109-3-25-M	M5-.8x5

* Supplied with one (1) set of beveled diagonal high speed TIN coated knurl wheels, 25 TPI (1.00mm)

** See Page H-54 for optional arms and specifications

*** Warning: This tool has the capability to adjust the wheels until they touch, but physically applying a knurl on small diameters may not be possible

Interchangeable W109 Arms Sets for 1.50" - 2.50" Diameter Capacity Tools

Heavy Duty Style Set						
Description	UPC #	Knurl Wheel Series	Knurl Pin Set	UPC #	All Set Screws	
W109-3-25-M	22848	M*	KPS-31-100	28845	M5-.8	

* Knurl wheels sold separately

Shoulder Style Set						
Description	UPC #	Knurl Wheel Series	Knurl PinSet	UPC #	All Set Screws	
W109-3-25-4	22849	SW4*	SW4.0P-2S	29085	M5-.8	

* Knurl wheels sold separately

Heavy Duty Style Set						
Description	UPC #	Knurl Wheel Series	Knurl Pin Set	UPC #	All Set Screws	
W109-3-40-O	22855	O*	KPS-31-125	28850	M5-.8	

* Knurl wheels sold separately

Shoulder Style Set						
Description	UPC #	Knurl Wheel Series	Knurl PinSet	UPC #	All Set Screws	
W109-3-40-4	22856	SW4*	SW4.0P-2S	29085	M5-.8	

* Knurl wheels sold separately

Infinite Lengths



 **Three Wheel**

 **Knurling Tool**

 **DORIAN
TOOL**

Three Wheel Knurling Tool

Infinite Lengths with Diameters Small as .085" (2,16mm) to 1.500"

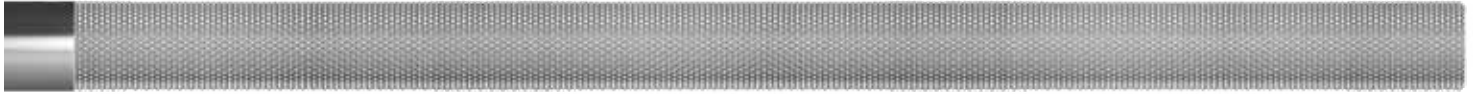

**3-Wheel Knurling Tool
Heavy Duty Shoulderless**



**3-Wheel Knurling Tool
to the Shoulder**

Three wheel knurling tool properties

1. For small diameters

When side pressure does not allow the use of a one or two wheel knurling tool.

2. For long lengths

When support or live center is not permissible. The part would deflect if a standard one or two wheel knurling tool is used.

3. For high precision knurling

When the finished diameter of the knurled part demands close tolerance. The three wheel knurling system applies less pressure per wheel controlling the displacement and the form of the material. This makes the knurl uniform and precise.

4. For high production

When high performance and quality need not sacrifice high production.

5. For automation

When cost is a factor. The high performance of this tool will keep the manufacturing cost lower.

6. Which machine to use on

Automatic Screw Machines, CNC Lathes, and Turret Lathes.

Three wheel knurling tool Features:

- Minimum diameter .085" (2,16mm)
- Maximum diameter 1.500" (38,1mm)
- For straight or diamond knurl
- Infinite lengths
- Precise scroll gear
- Fine diameter adjustment
- Dial allows for visual diameter adjustment
- Knurl to a shoulder
- Self-adjust to parts and tool misalignment
- Easy to setup
- Simple to operate
- Manual knurl diameter release for manual lathes

3WSKT -Three wheel knurling tool with optional round or square shanks

- Made of heat treated precision ground alloy steel.
- The dovetail guide and adjustable arms insure the most possible accuracy and rigidity.
- A precise scroll gear allows for fine diameter settings.
- Scaled dial makes setting the diameter easy.
- This tool is engineered for most required knurling jobs in Screw Machine, C.N.C. Lathe, and Turret Lathe Applications.
- Square shank can be reversed for right hand or left hand operation.
- Square shank with preset center height.

Resulting Knurl Pattern

Straight pattern
with 3 straight
wheels



Male 60° diamond pattern
with diagonal wheels
(2 DR - 1 DL or 1 DR - 2 DL)



Recommended Use:

For best results, use beveled knurl wheels. End-feed the knurling tool into the blank until the desired length of the knurl is done.

The Three Wheel Knurling Tool can knurl up to a shoulder, minimum diameter of .085" (2,16mm) up to 1.500" (38,1mm) diameter, and infinite lengths. The Heavy Duty Three Wheel Knurling Tool is recommended for shoulderless applications for improved wheel life. For Screw Machine, C.N.C. Lathe, and Turret Lathe Applications.

3 Wheel Knurling Tool Head to the Shoulder

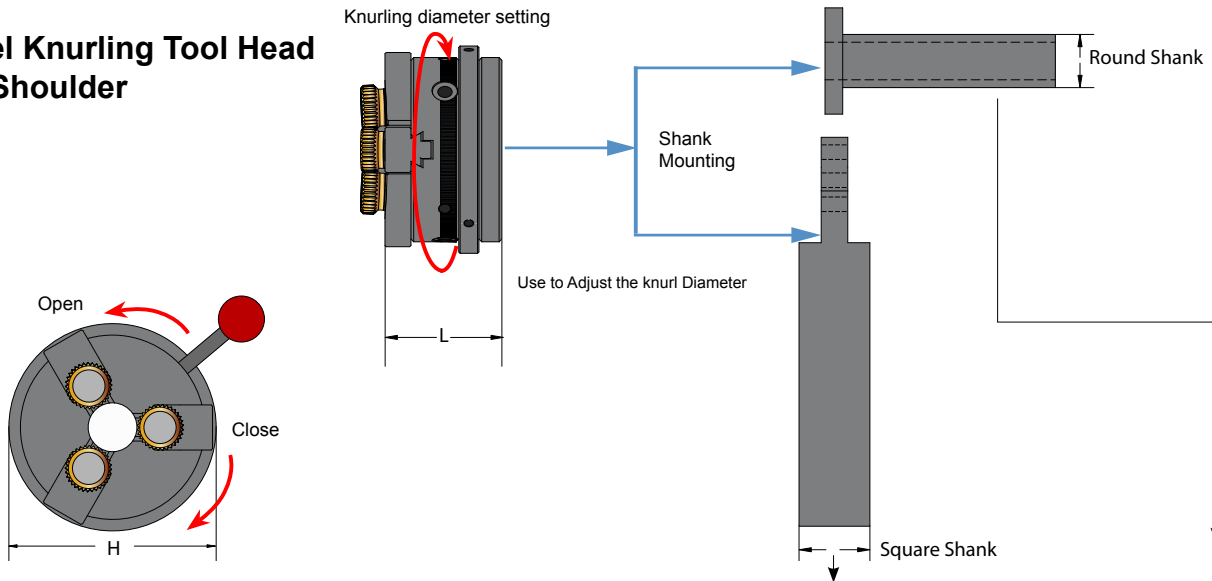

3 Wheels Knurling Tool Head Specification							
Description	UPC #	Max. Capacity	H Body	L Width	Knurl Wheel Series	Knurl Pin Set	UPC #
3WKT-06-2	23004	2.16mm to 6.4mm (.085" to 0.250")	44.5mm (1.750")	40.0mm (1.575")	SW2 *	SW2.0P-3S	29060
3WKT-12-2	23009	2.16mm to 12.7mm (.085" to 0.500")	57.2mm (2.250")	40.0mm (1.575")	SW2 *	SW2.0P-3S	29060
3WKT-25-2	23024	3.2mm to 25.4mm (0.125" to 1.000")	76.2mm (3.000")	40.0mm (1.575")	SW2 *	SW2.0P-3S	29060
3WKT-40-2	23034	4.75mm to 38.1mm (.187" to 1.500")	108mm (4.250")	62.0mm (2.440")	SW2 *	SW2.0P-3S	29060

Optional Square Shank			
Description	UPC #	Shank Size	
		Square	Length
3WSKT-06-12	23096	12mm	75mm
3WSKT-06-50	23095	.500"	3.00"
3WSKT-06-162	23097	16mm	88mm
		.625"	3.50"
3WSKT-06-20	23098	20mm	100mm
3WSKT-06-75	23099	.750"	4.00"
3WSKT-12-162	23082	16mm	88mm
		.625"	3.50"
3WSKT-12-20	23100	20mm	100mm
3WSKT-12-75	23102	.750"	4.00"
3WSKT-12-25	23101	25mm	125mm
3WSKT-12-100	23078	1.00"	5.00"
3WSKT-25-20	23103	20mm	100mm
3WSKT-25-75	23079	.750"	4.00"
3WSKT-25-25	23104	25mm	125mm
3WSKT-25-100	23080	1.00"	5.00"
3WSKT-40-25	23113	25mm	125mm
3WSKT-40-100	23081	1.00"	5.00"

Optional Round Shank			
Description	UPC #	Shank Size	
		Dia.	Length
3WRKT-06-12	23105	12mm	75mm
3WRKT-06-50	23110	.500"	3.00"
3WRKT-06-162	23106	16mm	88mm
		.625"	3.50"
3WRKT-06-20	23107	20mm	100mm
3WRKT-06-75	23111	.750"	4.00"
3WRKT-12-162	23115	16mm	88mm
		.625"	3.50"
3WRKT-12-20	23116	20mm	100mm
3WRKT-12-75	23112	.750"	4.00"
3WRKT-12-25	23117	25mm	125mm
3WRKT-12-100	23114	1.00"	5.00"
3WRKT-25-20	23125	20mm	100mm
3WRKT-25-75	23130	.750"	4.00"
3WRKT-25-25	23126	25mm	125mm
3WRKT-25-100	23124	1.00"	5.00"
3WRKT-40-25	23135	25mm	125mm
3WRKT-40-100	23140	1.00"	5.00"

3-Wheel Knurling Tool Heavy Duty Shoulderless

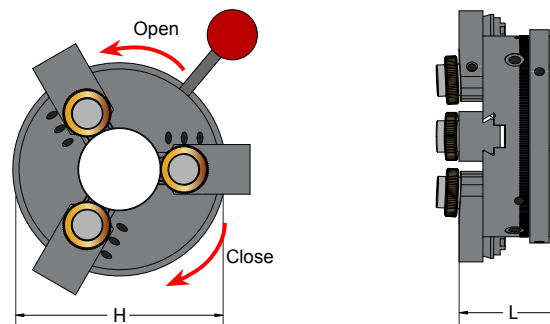

3-WHEEL KNURLING TOOL HEAVY DUTY SHOULDERLESS

3 Wheels Knurling Tool Head Specification							
Description	UPC #	Capacity	H	L	Knurl Wheel Series	Knurl Pin Set	UPC #
3WKT-40-M	23033	4.75mm to 38.1mm (.187" to 1.500")	108mm (4.250")	67.2mm (2.645")	M**	SM4.0P-3S	29092

Optional Square Shank			
Description	UPC #	Shank Size	
		Square	Length
3WSKT-40-25	23113	25mm	125mm
3WSKT-40-100	23081	1.00"	5.00"

Optional Round Shank			
Description	UPC #	Shank Size	
		Square	Length
3WRKT-40-25	23135	25mm	125mm
3WRKT-40-100	23140	1.00"	5.00"

Knurl Tool Head and Optional Shanks are Sold Separately

* Supplied with one (1) set of two (2) diagonal right and one (1) diagonal left beveled high speed TiN coated knurl wheels, 30 TPI (0.8mm)

** Supplied with one (1) set of two (2) diagonal right and one (1) diagonal left beveled high speed TiN coated knurl wheels, 25 TPI (1.0mm)

*** One (1) set consists of three (3) knurling pins and washers

Circular Pitch Inch and Metric

Knurl Pattern	Coarse					Medium			Fine				
	TPI	8	10	12	14	16	20	25	30	35	40	50	80
Tooth Angle	90°	90°	90°	90°	90°	90°	90°	90°	90°	90°	90°	70°	70°
Circular Pitch Inch	0.125	0.100	0.083	0.071	0.063	0.050	0.040	0.033	0.029	0.025	0.020	0.013	
Circular Pitch mm	3.2	2.5	2.0	1.8	1.6	1.2	1.0	0.8	0.7	0.6	0.5	0.3	

Diametral Pitch

DP	64	96	128	160
Tooth Angle α°	80°	80°	80°	80°

- **TPI system** is the number of teeth per inch (measured on a linear inch).
- **Circular pitch Inch system** is the distance from tooth to tooth, or is derived from 1" divided by the number of teeth per inch.
- **Circular pitch metric system** is the distance from tooth to tooth in mm.
- **Diametral pitch system** is derived by the number of teeth per inch on the work divided by the theoretical work blank diameter.

Knurling Wheel Identification

Knurl Pattern

S- Straight	DR- Diagonal Right	DL- Diagonal Left	M- Male Diamond	F- Female Diamond
-----------------------	------------------------------	-----------------------------	---------------------------	-----------------------------

TPI

TPI is the number of teeth per inch.

Circular Pitch is the distance between tooth to tooth

Edge Prep

Full Faced F	Beveled Edge B
---------------------	-----------------------

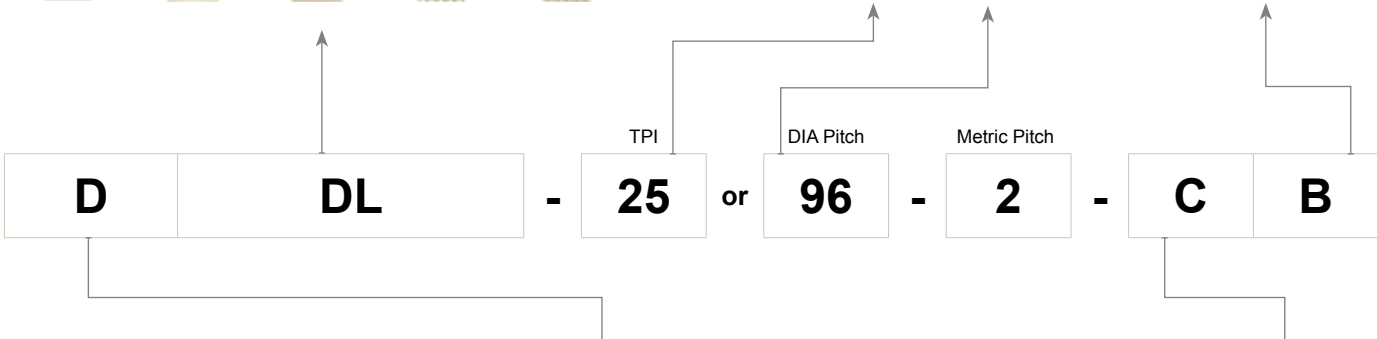

Knurl Wheel Series	Material											
	A	B	C	D	M	O	P	R	S	SW2	SW4	C - Cobalt (TiN Coated) HS - High Speed (TiN Coated)
DIA.	.750	.3125	.500	.500	1.00	1.00	1.25	.750	.750	.500	1.00	
THK.	.375	.1562	.1875	.1562	.236	.375	.500	.197	.250	.250	.375	
HOLE	.250	.125	.1875	.1875	.3125	.3125	.500	.250	.250	.250	.500	

Knurling Wheel Tooth Pattern & Workpiece Knurl Pattern

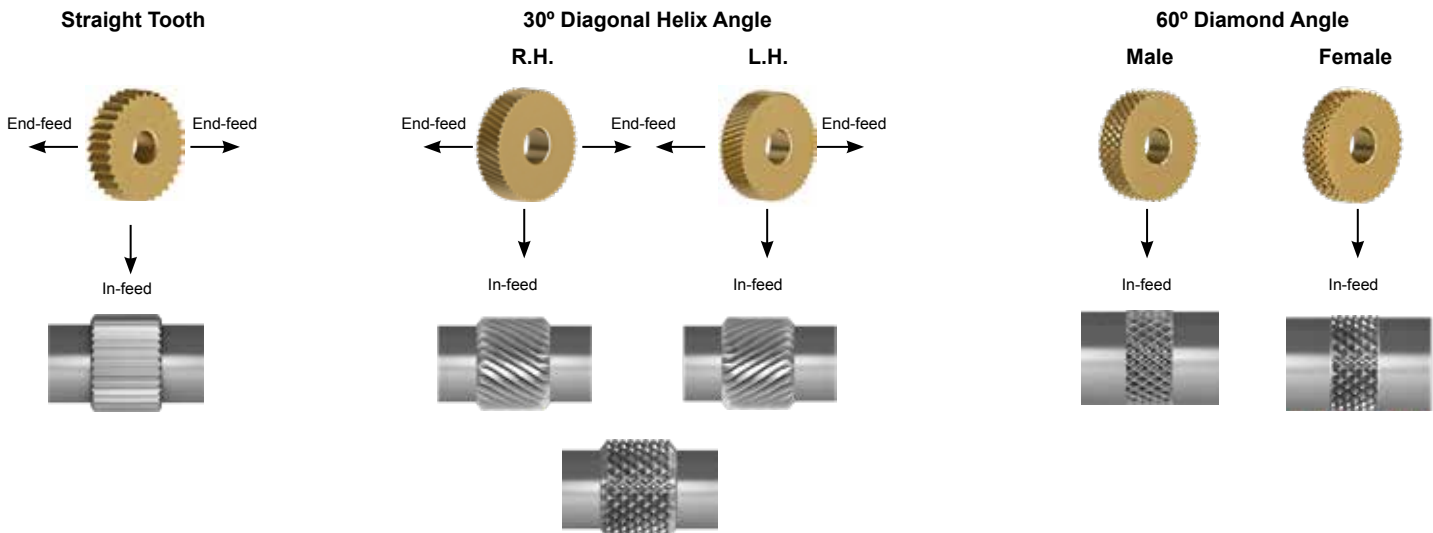

Knurl Wheel Technology

Dorian knurl wheels are engineered and manufactured with the highest Quality Standards and precise workmanship, to meet and exceed industry requirements in working performance and tool life expectancy.

All knurl wheels are available in High Speed Tool Steel or 8.5% Cobalt content Tool Steel.



Every knurl wheel is individually hob cut, heat-treated, and ground to precise tolerance. The teeth are lapped to a smooth surface finish in order to create a hard and precise tooth.

The knurl wheels are TiN coated to improve the working performance and generate a smooth and clean surface of the knurled part.



Knurl Wheel Material

High Speed Wheels:

The high speed tool steel knurl wheels are tough and shock resistant.

First Choice: to knurl hard to machine materials such as Carbon Steel, Alloy Steel, and Stainless Steel.

Cobalt Wheels:

The 8.5% cobalt content adds hardness and wear resistance to the wheels.

First Choice: to knurl abrasive and soft materials such as Free Machining Steel, Aluminum, and nonferrous materials

Knurl Wheel Edge Prep

For knurl cutting, use full faced knurl wheels only.

For end-feed form knurling, use beveled knurl wheels only.

For in-feed form knurling, beveled or full faced may be used.

Knurl Forming (plunge) Versus Knurl Cutting

Knurl Forming

The force applied through knurl forming is increased with harder materials, larger knurled diameter parts and larger knurl pitch, making knurling slow and difficult. The excessive pressure applied in form knurling may damage the spindle of the machine.

First Choice:

- Small diameter parts under 1" or 25 mm
- Larger diameters of soft material as Aluminum and low Carbon Steel
- When high surface finished is required
- When high precision knurl pitch is required
- Knurling to square shoulder
- Band in center of the part
- Manual Lathe

Knurl Cutting

The force applied through knurl cutting versus knurl forming is decreased to the same level of a turning operation because the knurl wheels cut instead of forming the blank, making knurling faster and easier, with no damage to the spindle of the machine.

First Choice;

- Diameter parts over 1/2" or 12 mm
- Larger diameters of any material
- When high surface finish is not required
- When high precision knurl pitch is not required
- Knurling to open diameter
- Cosmetic Knurling
- High production
- CNC Turning Center

SFM Knurling

SFM Knurl Forming

For speed and feed, see Page H-16.

SFM Knurl Cutting

For speed and feed, See Page H-16.

Knurl Wheels

A Series

For knurl cutting, use full faced knurl wheels only.
 For end-feed form knurling, use beveled knurl wheels only.
 For in-feed form knurling, beveled or full faced may be used.
 Knurl wheels can be reversed for right or left hand operation.

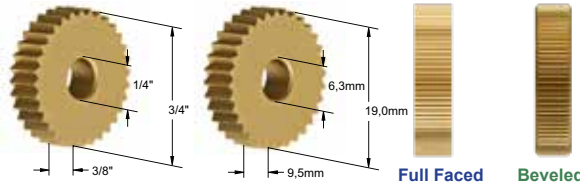

Knurl wheels are TiN coated to reduce the coefficient of friction when knurling, increasing the quality and the force of knurling as well as the life of the knurl wheels.

Circular Knurl Pitch		Included Tooth Angle	Knurl Pattern	A Series Knurl Wheel	Straight		Diagonal Right		Diagonal Left		Diamond	
Inch	Metric				High Speed TiN Coated	Cobalt TiN Coated	High Speed TiN Coated	Cobalt TiN Coated	High Speed TiN Coated	Cobalt TiN Coated	Male High Speed TiN Coated	Female High Speed TiN Coated
08 (TPI)	3,2mm	90°	Coarse	Description	AS-08-HS	AS-08-C	ADR-08-HS	ADR-08-C	ADL-08-HS	ADL-08-C	AM-08-HS	AF-08-HS
				Tracking Data	19T / .0400"	19T / .0400"	16T / .0475"	16T / .0475"	16T / .0475"	16T / .0475"	16T / .0475"	16T / .0475"
				Full Faced	-	-	-	-	-	-	-	-
				Beveled	-	-	-	-	-	-	-	-
					-	-	-	-	-	-	-	-
10 (TPI)	2,5mm	90°	Coarse	Description	AS-10-HS	AS-10-C	ADR-10-HS	ADR-10-C	ADL-10-HS	ADL-10-C	AM-10-HS	AF-10-HS
				Tracking Data	23T / .0330"	23T / .0330"	20T / .0380"	20T / .0380"	20T / .0380"	20T / .0380"	20T / .0380"	20T / .0380"
				Full Faced	23502	-	23634	23700	23766	23832	-	-
				Beveled	-	-	23667	-	23799	-	-	-
					-	-	-	-	-	-	-	-
12 (TPI)	2,0mm	90°	Coarse	Description	AS-12-HS	AS-12-C	ADR-12-HS	ADR-12-C	ADL-12-HS	ADL-12-C	AM-12-HS	AF-12-HS
				Tracking Data	28T / .0271"	28T / .0271"	25T / .0304"	25T / .0304"	25T / .0304"	25T / .0304"	25T / .0304"	25T / .0304"
				Full Faced	23504	-	23636	23702	23768	23834	-	-
				Beveled	23537	23603	23669	-	23801	-	-	-
					-	-	-	-	-	-	-	-
14 (TPI)	1,8mm	90°	Coarse	Description	AS-14-HS	AS-14-C	ADR-14-HS	ADR-14-C	ADL-14-HS	ADL-14-C	AM-14-HS	AF-14-HS
				Tracking Data	34T / .0224"	34T / .0224"	34T / .0224"	34T / .0224"	34T / .0224"	34T / .0224"	34T / .0224"	34T / .0224"
				Full Faced	23506	-	23638	-	23770	-	-	-
				Beveled	-	-	23671	23737	23803	23869	-	-
					-	-	-	-	-	-	-	-
16 (TPI)	1,6mm	90°	Coarse	Description	AS-16-HS	AS-16-C	ADR-16-HS	ADR-16-C	ADL-16-HS	ADL-16-C	AM-16-HS	AF-16-HS
				Tracking Data	38T / .0200"	38T / .0200"	33T / .0230"	33T / .0230"	33T / .0230"	33T / .0230"	33T / .0230"	33T / .0230"
				Full Faced	23508	-	23640	23706	23772	23838	-	23970
				Beveled	23541	23607	-	-	-	-	-	-
					-	-	-	-	-	-	-	-
20 (TPI)	1,2mm	90°	Medium	Description	AS-20-HS	AS-20-C	ADR-20-HS	ADR-20-C	ADL-20-HS	ADL-20-C	AM-20-HS	AF-20-HS
				Tracking Data	47T / .0161"	47T / .0161"	41T / .0185"	41T / .0185"	41T / .0185"	41T / .0185"	41T / .0185"	41T / .0185"
				Full Faced	23510	23576	23642	23708	23774	23840	-	-
				Beveled	23543	-	23675	-	23807	-	23939	-
					-	-	-	-	-	-	-	-
25 (TPI)	1,0mm	90°	Medium	Description	AS-25-HS	AS-25-C	ADR-25-HS	ADR-25-C	ADL-25-HS	ADL-25-C	AM-25-HS	AF-25-HS
				Tracking Data	59T / .0128"	59T / .0128"	51T / .0148"	51T / .0148"	51T / .0148"	51T / .0148"	51T / .0148"	51T / .0148"
				Full Faced	23512	23578	23644	23710	23776	23842	23908	-
				Beveled	-	23611	23677	23743	23809	23875	-	-
					-	-	-	-	-	-	-	-
30 (TPI)	0,8mm	90°	Medium	Description	AS-30-HS	AS-30-C	ADR-30-HS	ADR-30-C	ADL-30-HS	ADL-30-C	AM-30-HS	AF-30-HS
				Tracking Data	71T / .0106"	71T / .0106"	61T / .0124"	61T / .0124"	61T / .0124"	61T / .0124"	61T / .0124"	61T / .0124"
				Full Faced	23514	23580	23646	-	23778	-	-	-
				Beveled	-	23613	-	-	-	-	-	-
					-	-	-	-	-	-	-	-
35 (TPI)	0,7mm	90°	Medium	Description	AS-35-HS	AS-35-C	ADR-35-HS	ADR-35-C	ADL-35-HS	ADL-35-C	AM-35-HS	AF-35-HS
				Tracking Data	82T / .0092"	82T / .0092"	71T / .0106"	71T / .0106"	71T / .0106"	71T / .0106"	71T / .0106"	71T / .0106"
				Full Faced	23616	23582	-	-	-	-	-	-
				Beveled	-	23615	-	23747	-	23879	-	-
					-	-	-	-	-	-	-	-
40 (TPI)	0,6mm	90°	Medium	Description	AS-40-HS	AS-40-C	ADR-40-HS	ADR-40-C	ADL-40-HS	ADL-40-C	AM-40-HS	AF-40-HS
				Tracking Data	94T / .0080"	94T / .0080"	81T / .0093"	81T / .0093"	81T / .0093"	81T / .0093"	81T / .0093"	81T / .0093"
				Full Faced	23518	-	23650	-	23782	-	23914	-
				Beveled	-	23617	23683	-	23815	-	-	-
					-	-	-	-	-	-	-	-
50 (TPI)	0,5mm	70°	Fine	Description	AS-50-HS	AS-50-C	ADR-50-HS	ADR-50-C	ADL-50-HS	ADL-50-C	AM-50-HS	AF-50-HS
				Tracking Data	117T / .0064"	117T / .0064"	102T / .0074"	102T / .0074"	102T / .0074"	102T / .0074"	102T / .0074"	102T / .0074"
				Full Faced	23520	-	23652	-	23784	-	23916	-
				Beveled	-	23619	-	-	-	-	-	-
					-	-	-	-	-	-	-	-
80 (TPI)	0,3mm	70°	Fine	Description	AS-80-HS	AS-80-C	ADR-80-HS	ADR-80-C	ADL-80-HS	ADL-80-C	AM-80-HS	AF-80-HS
				Tracking Data	189T / .0040"	189T / .0040"	163T / .0046"	163T / .0046"	163T / .0046"	163T / .0046"	163T / .0046"	163T / .0046"
				Full Faced	-	-	-	-	-	-	-	-
				Beveled	-	-	-	-	-	-	-	-
					-	-	-	-	-	-	-	-
Diametral Pitch												
64	1,2mm	80°	Medium	Description	AS-64-HS	AS-64-C	ADR-64-HS	ADR-64-C	ADL-64-HS	ADL-64-C	AM-64-HS	AF-64-HS
				Tracking Data	48T / .0156	48T / .0156	48T / .0156	48T / .0156	48T / .0156	48T / .0156	48T / .0156	48T / .0156
				Full Faced	23524	-	-	-	-	-	-	-
				Beveled	-	-	-	-	-	-	-	-
					-	-	-	-	-	-	-	-
96	0,8mm	80°	Medium	Description	AS-96-HS	AS-96-C	ADR-96-HS	ADR-96-C	ADL-96-HS	ADL-96-C	AM-96-HS	AF-96-HS
				Tracking Data	72T / .0104"	72T / .0104"	72T / .0104"	72T / .0104"	72T / .0104"	72T / .0104"	72T / .0104"	72T / .0104"
				Full Faced	23526	-	23658	-	23790	-	-	-
				Beveled	23559	-	23691	23757	23823	-	-	-
					-	-	-	-	-	-	-	-
128	0,6mm	80°	Fine	Description	AS-128-HS	AS-128-C	ADR-128-HS	ADR-128-C	ADL-128-HS	ADL-128-C	AM-128-HS	AF-128-HS
				Tracking Data	96T / .0078"	96T / .0078"	96T / .0078"	96T / .0078"	96T / .0078"	96T / .0078"	96T / .0078"	96T / .0078"
				Full Faced	23528	-	23660	23726	23792	23858	-	-
				Beveled	-	-	-	-	-	-	-	-
					-	-	-	-	-	-	-	-
160	0,5mm	80°	Fine	Description	AS-160-HS	AS-160-C	ADR-160-HS	ADR-160-C	ADL-160-HS	ADL-160-C	AM-160-HS	AF-160-HS
				Tracking Data	120T / .0063"	120T / .0063"	120T / .0063"	120T / .0063"	120T / .0063"	120T / .0063"	120T / .0063"	120T / .0063"
				Full Faced	-	-	-	-	-	-	-	-
				Beveled	-	-	-	-	-	-	-	-
					-	-	-	-	-	-	-	-

B Series

For knurl cutting, use full faced knurl wheels only.

For end-feed form knurling, use beveled knurl wheels only.

For in-feed form knurling, beveled or full faced may be used.

Knurl wheels can be reversed for right or left hand operation.

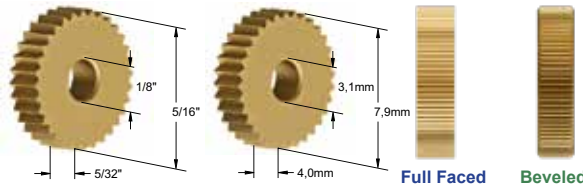

Knurl wheels are TiN coated to reduce the coefficient of friction when knurling, increasing the quality and the force of knurling as well as the life of the knurl wheels.

Circular Knurl Pitch		Included Tooth Angle	Knurl Pattern	B Series Knurl Wheel	Straight		Diagonal Right		Diagonal Left		Diamond		
Inch	Metric				High Speed TiN Coated	Cobalt TiN Coated	High Speed TiN Coated	Cobalt TiN Coated	High Speed TiN Coated	Cobalt TiN Coated	Male High Speed TiN Coated	Female High Speed TiN Coated	
20 (TPI)	1,2mm	90°	Medium	Description	BS-20-HS	BS-20-C	BDR-20-HS	BDR-20-C	BDL-20-HS	BDL-20-C	BM-20-HS	BF-20-HS	
				Tracking Data	19T / .0168"	19T / .0168"	17T / .0188"	17T / .0188"	17T / .0188"	17T / .0188"	17T / .0188"	17T / .0188"	
				Full Faced	-	-	-	-	-	-	-	-	
Beveled	-	-		-	-	-	-	-	-				
25 (TPI)	1,0mm	90°		Description	BS-25-HS	BS-25-C	BDR-25-HS	BDR-25-C	BDL-25-HS	BDL-25-C	BM-25-HS	BF-25-HS	
				Tracking Data	25T / .0128"	25T / .0128"	21T / .0152"	21T / .0152"	21T / .0152"	21T / .0152"	21T / .0152"	21T / .0152"	
				Full Faced	-	-	-	-	-	-	-	-	
Beveled	-	-		-	-	-	-	-	-				
30 (TPI)	0,8mm	90°		Description	BS-30-HS	BS-30-C	BDR-30-HS	BDR-30-C	BDL-30-HS	BDL-30-C	BM-30-HS	BF-30-HS	
			Tracking Data	29T / .0110"	29T / .0110"	26T / .0122"	26T / .0122"	26T / .0122"	26T / .0122"	26T / .0122"	26T / .0122"		
			Full Faced	-	-	-	-	-	-	24382	-		
Beveled	24129	-	24221	-	24313	-	-	-					
35 (TPI)	0,7mm	90°	Description	BS-35-HS	BS-35-C	BDR-35-HS	BDR-35-C	BDL-35-HS	BDL-35-C	BM-35-HS	BF-35-HS		
			Tracking Data	34T / .0093"	34T / .0093"	29T / .0110"	29T / .0110"	29T / .0110"	29T / .0110"	29T / .0110"	29T / .0110"		
			Full Faced	-	24154	24200	-	24292	-	-	-		
Beveled	-	-	-	-	-	-	-	-					
40 (TPI)	0,6mm	90°	Description	BS-40-HS	BS-40-C	BDR-40-HS	BDR-40-C	BDL-40-HS	BDL-40-C	BM-40-HS	BF-40-HS		
			Tracking Data	39T / .0081"	39T / .0081"	34T / .0093"	34T / .0093"	34T / .0093"	34T / .0093"	34T / .0093"	34T / .0093"		
			Full Faced	24110	24156	24202	24248	24294	24340	-	-		
Beveled	-	-	-	-	-	-	-	-					
50 (TPI)	0,5mm	70°	Description	BS-50-HS	BS-50-C	BDR-50-HS	BDR-50-C	BDL-50-HS	BDL-50-C	BM-50-HS	BF-50-HS		
			Tracking Data	49T / .0064"	49T / .0064"	43T / .0073"	43T / .0073"	43T / .0073"	43T / .0073"	43T / .0073"	43T / .0073"		
			Full Faced	-	24158	-	-	-	-	24388	-		
Beveled	-	-	-	-	-	-	-	-					
80 (TPI)	0,3mm	70°	Description	BS-80-HS	BS-80-C	BDR-80-HS	BDR-80-C	BDL-80-HS	BDL-80-C	BM-80-HS	BF-80-HS		
			Tracking Data	79T / .0040"	79T / .0040"	68T / .0046"	68T / .0046"	68T / .0046"	68T / .0046"	68T / .0046"	68T / .0046"		
			Full Faced	-	-	-	-	-	-	-	-		
Beveled	24137	-	-	-	-	-	-	-					
Diametral Pitch													
96	0,8mm	80°	Medium	Description	BS-96-HS	BS-96-C	BDR-96-HS	BDR-96-C	BDL-96-HS	BDL-96-C	BM-96-HS	BF-96-HS	
				Tracking Data	30T / .0104"	30T / .0104"	30T / .0104"	30T / .0104"	30T / .0104"	30T / .0104"	30T / .0104"	30T / .0104"	
				Full Faced	24116	24162	24208	-	24300	-	-	-	
Beveled	-	-		-	-	-	-	-	-				
128	0,6mm	80°		Fine	Description	BS-128-HS	BS-128-C	BDR-128-HS	BDR-128-C	BDL-128-HS	BDL-128-C	BM-128-HS	BF-128-HS
					Tracking Data	40T / .0078"	40T / .0078"	40T / .0078"	40T / .0078"	40T / .0078"	40T / .0078"	40T / .0078"	40T / .0078"
					Full Faced	24118	-	24210	-	24302	-	-	-
Beveled	-	-			-	-	-	-	-	-			
160	0,5mm	80°			Description	BS-160-HS	BS-160-C	BDR-160-HS	BDR-160-C	BDL-160-HS	BDL-160-C	BM-160-HS	BF-160-HS
			Tracking Data		50T / .0063"	50T / .0063"	50T / .0063"	50T / .0063"	50T / .0063"	50T / .0063"	50T / .0063"	50T / .0063"	
			Full Faced		24120	-	-	-	-	-	-	-	
Beveled	-	-	-		-	-	-	-	-				

A	Knurl wheel size
S	Knurl wheel pattern
08	TPI number of teeth per inches
HS	Knurl wheel material
19T	Number of the teeth of the wheel
.400	Tracking value
F	Full face knurl wheel
B	Beveled edge knurl wheel

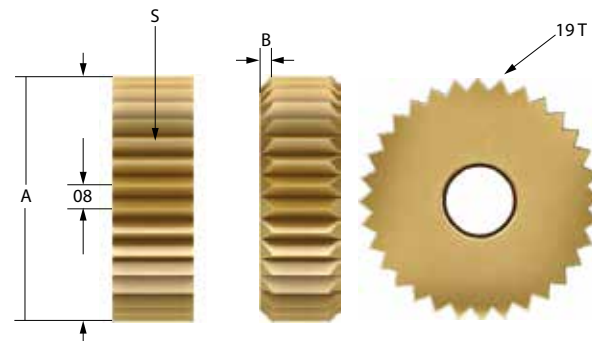

C Series

For knurl cutting, use full faced knurl wheels only.

For end-feed form knurling, use beveled knurl wheels only.

For in-feed form knurling, beveled or full faced may be used.

Knurl wheels can be reversed for right or left hand operation.

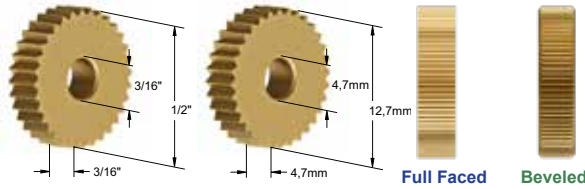

Knurl wheels are TiN coated to reduce the coefficient of friction when knurling, increasing the quality and the force of knurling as well as the life of the knurl wheels.

Circular Knurl Pitch		Included Tooth Angle	Knurl Pattern	C Series Knurl Wheel	Straight		Diagonal Right		Diagonal Left		Diamond	
Inch	Metric				High Speed TiN Coated	Cobalt TiN Coated	High Speed TiN Coated	Cobalt TiN Coated	High Speed TiN Coated	Cobalt TiN Coated	Male High Speed TiN Coated	Female High Speed TiN Coated
16 (TPI)	1,6mm	90°	Coarse	Description	CS-16-HS	CS-16-C	CDR-16-HS	CDR-16-C	CDL-16-HS	CDL-16-C	CM-16-HS	CF-16-HS
				Tracking Data	25T / .0204"	25T / .0204"	22T / .0232"	22T / .0232"	22T / .0232"	22T / .0232"	22T / .0232"	22T / .0232"
				Full Faced	24502	-	24610	-	24718	-	-	-
				Beveled	-	-	-	-	-	-	-	-
20 (TPI)	1,2mm	90°	Medium	Description	CS-20-HS	CS-20-C	CDR-20-HS	CDR-20-C	CDL-20-HS	CDL-20-C	CM-20-HS	CF-20-HS
				Tracking Data	31T / .0164"	31T / .0164"	27T / .0188"	27T / .0188"	27T / .0188"	27T / .0188"	27T / .0188"	27T / .0188"
				Full Faced	24504	-	-	-	-	-	-	-
				Beveled	-	-	-	-	-	-	-	-
25 (TPI)	1,0mm	90°	Medium	Description	CS-25-HS	CS-25-C	CDR-25-HS	CDR-25-C	CDL-25-HS	CDL-25-C	CM-25-HS	CF-25-HS
				Tracking Data	38T / .0133"	38T / .0133"	34T / .0149"	34T / .0149"	34T / .0149"	34T / .0149"	34T / .0149"	34T / .0149"
				Full Faced	24506	-	24614	24668	24722	24776	-	24884
				Beveled	-	-	24641	-	24749	-	-	-
30 (TPI)	0,8mm	90°	Medium	Description	CS-30-HS	CS-30-C	CDR-30-HS	CDR-30-C	CDL-30-HS	CDL-30-C	CM-30-HS	CF-30-HS
				Tracking Data	47T / .0107"	47T / .0107"	40T / .0126"	40T / .0126"	40T / .0126"	40T / .0126"	40T / .0126"	40T / .0126"
				Full Faced	24508	24562	24616	24670	24724	24778	-	-
				Beveled	-	-	-	-	-	-	-	
35 (TPI)	0,7mm	90°	Medium	Description	CS-35-HS	CS-35-C	CDR-35-HS	CDR-35-C	CDL-35-HS	CDL-35-C	CM-35-HS	CF-35-HS
				Tracking Data	55T / .0092"	55T / .0092"	47T / .0107"	47T / .0107"	47T / .0107"	47T / .0107"	47T / .0107"	47T / .0107"
				Full Faced	24510	-	-	-	-	-	-	-
				Beveled	-	-	-	-	-	-	-	
40 (TPI)	0,6mm	90°	Fine	Description	CS-40-HS	CS-40-C	CDR-40-HS	CDR-40-C	CDL-40-HS	CDL-40-C	CM-40-HS	CF-40-HS
				Tracking Data	63T / .0080"	63T / .0080"	55T / .0092"	55T / .0092"	55T / .0092"	55T / .0092"	55T / .0092"	55T / .0092"
				Full Faced	24512	24566	-	24674	-	24782	24836	-
				Beveled	-	-	-	-	-	-	-	
50 (TPI)	0,5mm	70°	Fine	Description	CS-50-HS	CS-50-C	CDR-50-HS	CDR-50-C	CDL-50-HS	CDL-50-C	CM-50-HS	CF-50-HS
				Tracking Data	79T / .0064"	79T / .0064"	68T / .0074"	68T / .0074"	68T / .0074"	68T / .0074"	68T / .0074"	68T / .0074"
				Full Faced	24514	24568	-	-	-	-	-	24892
				Beveled	-	-	-	-	-	-	-	
80 (TPI)	0,3mm	70°	Fine	Description	CS-80-HS	CS-80-C	CDR-80-HS	CDR-80-C	CDL-80-HS	CDL-80-C	CM-80-HS	CF-80-HS
				Tracking Data	125T / .0040"	125T / .0040"	107T / .0047"	107T / .0047"	107T / .0047"	107T / .0047"	107T / .0047"	107T / .0047"
				Full Faced	24516	24570	24624	24678	24732	24786	-	-
				Beveled	-	24597	-	-	-	-	-	
Diametral Pitch												
64	1,2mm	80°	Medium	Description	CS-64-HS	CS-64-C	CDR-64-HS	CDR-64-C	CDL-64-HS	CDL-64-C	CM-64-HS	CF-64-HS
				Tracking Data	32T / .0156"	32T / .0156"	32T / .0156"	32T / .0156"	32T / .0156"	32T / .0156"	32T / .0156"	32T / .0156"
				Full Faced	-	-	24626	24680	24734	24788	24842	-
				Beveled	-	-	-	-	-	-	-	
96	0,8mm	80°	Medium	Description	CS-96-HS	CS-96-C	CDR-96-HS	CDR-96-C	CDL-96-HS	CDL-96-C	CM-96-HS	CF-96-HS
				Tracking Data	48T / .0104"	48T / .0104"	48T / .0104"	48T / .0104"	48T / .0104"	48T / .0104"	48T / .0104"	48T / .0104"
				Full Faced	-	-	-	-	-	-	-	24898
				Beveled	-	-	-	-	-	-	-	
128	0,6mm	80°	Fine	Description	CS-128-HS	CS-128-C	CDR-128-HS	CDR-128-C	CDL-128-HS	CDL-128-C	CM-128-HS	CF-128-HS
				Tracking Data	64T / .0078"	64T / .0078"	64T / .0078"	64T / .0078"	64T / .0078"	64T / .0078"	64T / .0078"	64T / .0078"
				Full Faced	24522	-	-	-	-	-	-	-
				Beveled	-	-	-	-	-	-	-	
160	0,5mm	80°	Fine	Description	CS-160-HS	CS-160-C	CDR-160-HS	CDR-160-C	CDL-160-HS	CDL-160-C	CM-160-HS	CF-160-HS
				Tracking Data	80T / .0063"	80T / .0063"	80T / .0063"	80T / .0063"	80T / .0063"	80T / .0063"	80T / .0063"	80T / .0063"
				Full Faced	24524	24578	-	-	-	-	-	-
				Beveled	-	-	-	-	-	-	-	

D Series

For knurl cutting, use full faced knurl wheels only.
 For end-feed form knurling, use beveled knurl wheels only.
 For in-feed form knurling, beveled or full faced may be used.
 Knurl wheels can be reversed for right or left hand operation.

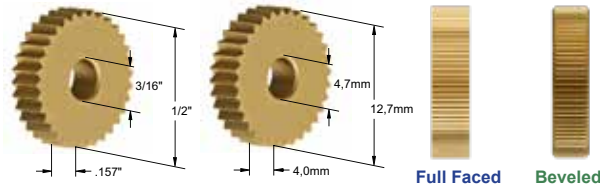

Knurl wheels are TiN coated to reduce the coefficient of friction when knurling, increasing the quality and the force of knurling as well as the life of the knurl wheels.

Circular Knurl Pitch		Included Tooth Angle	Knurl Pattern	D Series Knurl Wheel	Straight		Diagonal Right		Diagonal Left		Diamond	
Inch	Metric				High Speed TiN Coated	Cobalt TiN Coated	High Speed TiN Coated	Cobalt TiN Coated	High Speed TiN Coated	Cobalt TiN Coated	Female High Speed TiN Coated	Female Cobalt TiN Coated
16 (TPI)	1,6mm	90°	Coarse	Description	DS-16-HS	DS-16-C	DDR-16-HS	DDR-16-C	DDL-16-HS	DDL-16-C	DF-16-HS	DF-16-C
				Tracking Data	25T / .0204"	25T / .0204"	22T / .0232"	22T / .0232"	22T / .0232"	22T / .0232"	22T / .0232"	22T / .0232"
				Full Faced	25001	-	25055	25056	25109	25110	-	-
				Beveled	-	-	25082	25083	25136	25137	-	-
20 (TPI)	1,2mm	90°	Medium	Description	DS-20-HS	DS-20-C	DDR-20-HS	DDR-20-C	DDL-20-HS	DDL-20-C	DF-20-HS	DF-20-C
				Tracking Data	31T / .0164"	31T / .0164"	27T / .0188"	27T / .0188"	27T / .0188"	27T / .0188"	27T / .0188"	27T / .0188"
				Full Faced	25003	25004	25057	25058	25111	25112	-	-
				Beveled	25030	25031	25084	25085	25138	25139	25192	-
25 (TPI)	1,0mm	90°	Medium	Description	DS-25-HS	DS-25-C	DDR-25-HS	DDR-25-C	DDL-25-HS	DDL-25-C	DF-25-HS	DF-25-C
				Tracking Data	38T / .0133"	38T / .0133"	34T / .0149"	34T / .0149"	34T / .0149"	34T / .0149"	34T / .0149"	34T / .0149"
				Full Faced	25005	25006	25059	-	25113	-	-	-
				Beveled	25032	25033	25086	25087	25140	25141	-	-
30 (TPI)	0,8mm	90°	Medium	Description	DS-30-HS	DS-30-C	DDR-30-HS	DDR-30-C	DDL-30-HS	DDL-30-C	DF-30-HS	DF-30-C
				Tracking Data	47T / .0107"	47T / .0107"	40T / .0126"	40T / .0126"	40T / .0126"	40T / .0126"	40T / .0126"	40T / .0126"
				Full Faced	25007	25008	25061	25062	25115	25116	25169	25170
				Beveled	25034	25035	25088	25089	25142	25143	-	-
35 (TPI)	0,7mm	90°	Medium	Description	DS-35-HS	DS-35-C	DDR-35-HS	DDR-35-C	DDL-35-HS	DDL-35-C	DF-35-HS	DF-35-C
				Tracking Data	55T / .0092"	55T / .0092"	47T / .0107"	47T / .0107"	47T / .0107"	47T / .0107"	47T / .0107"	47T / .0107"
				Full Faced	25009	25010	25063	-	25117	-	-	-
				Beveled	25036	-	25090	-	25144	-	-	-
40 (TPI)	0,6mm	90°	Fine	Description	DS-40-HS	DS-40-C	DDR-40-HS	DDR-40-C	DDL-40-HS	DDL-40-C	DF-40-HS	DF-40-C
				Tracking Data	63T / .0080"	63T / .0080"	55T / .0092"	55T / .0092"	55T / .0092"	55T / .0092"	55T / .0092"	55T / .0092"
				Full Faced	-	-	25065	-	25119	-	-	25174
				Beveled	25038	25039	25092	25093	25146	25147	-	-
50 (TPI)	0,5mm	70°	Fine	Description	DS-50-HS	DS-50-C	DDR-50-HS	DDR-50-C	DDL-50-HS	DDL-50-C	DF-50-HS	DF-50-C
				Tracking Data	79T / .0064"	79T / .0064"	68T / .0074"	68T / .0074"	68T / .0074"	68T / .0074"	68T / .0074"	68T / .0074"
				Full Faced	25013	-	25067	-	25121	-	-	-
				Beveled	25040	25041	25094	-	25148	-	-	-
80 (TPI)	0,3mm	70°	Fine	Description	DS-80-HS	DS-80-C	DDR-80-HS	DDR-80-C	DDL-80-HS	DDL-80-C	DF-80-HS	DF-80-C
				Tracking Data	125T / .0040"	125T / .0040"	107T / .0047"	107T / .0047"	107T / .0047"	107T / .0047"	107T / .0047"	107T / .0047"
				Full Faced	25015	25016	25069	-	25123	-	-	-
				Beveled	-	25043	-	25097	-	25151	-	25205
Diametral Pitch												
64	1,2mm	80°	Medium	Description	DS-64-HS	DS-64-C	DDR-64-HS	DDR-64-C	DDL-64-HS	DDL-64-C	DF-64-HS	DF-64-C
				Tracking Data	32T / .0156"	32T / .0156"	32T / .0156"	32T / .0156"	32T / .0156"	32T / .0156"	32T / .0156"	32T / .0156"
				Full Faced	25017	-	-	-	-	-	-	-
				Beveled	-	-	25099	-	25153	-	-	-
96	0,8mm	80°	Medium	Description	DS-96-HS	DS-96-C	DDR-96-HS	DDR-96-C	DDL-96-HS	DDL-96-C	DF-96-HS	DF-96-C
				Tracking Data	48T / .0104"	48T / .0104"	48T / .0104"	48T / .0104"	48T / .0104"	48T / .0104"	48T / .0104"	48T / .0104"
				Full Faced	25019	-	-	25074	-	25128	-	25181
				Beveled	25046	-	-	25101	-	25155	-	-
128	0,6mm	80°	Fine	Description	DS-128-HS	DS-128-C	DDR-128-HS	DDR-128-C	DDL-128-HS	DDL-128-C	DF-128-HS	DF-128-C
				Tracking Data	64T / .0078"	64T / .0078"	64T / .0078"	64T / .0078"	64T / .0078"	64T / .0078"	64T / .0078"	64T / .0078"
				Full Faced	25021	-	-	25076	-	25130	-	-
				Beveled	25048	-	-	-	-	-	-	-
160	0,5mm	80°	Fine	Description	DS-160-HS	DS-160-C	DDR-160-HS	DDR-160-C	DDL-160-HS	DDL-160-C	DF-160-HS	DF-160-C
				Tracking Data	80T / .0063"	80T / .0063"	80T / .0063"	80T / .0063"	80T / .0063"	80T / .0063"	80T / .0063"	80T / .0063"
				Full Faced	-	25024	-	25078	-	25132	-	-
				Beveled	-	25051	-	-	-	-	-	-

M Series

For knurl cutting, use full faced knurl wheels only.

For end-feed form knurling, use beveled knurl wheels only.

For in-feed form knurling, beveled or full faced may be used.

Knurl wheels can be reversed for right or left hand operation.

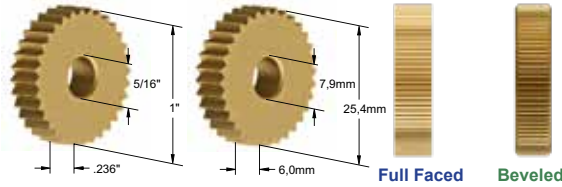

Knurl wheels are TiN coated to reduce the coefficient of friction when knurling, increasing the quality and the force of knurling as well as the life of the knurl wheels.

Circular Knurl Pitch		Included Tooth Angle	Knurl Pattern	M Series Knurl Wheel	Straight		Diagonal Right		Diagonal Left		Diamond	
Inch	Metric				High Speed TiN Coated	Cobalt TiN Coated	High Speed TiN Coated	Cobalt TiN Coated	High Speed TiN Coated	Cobalt TiN Coated	Female High Speed TiN Coated	Female Cobalt TiN Coated
10 (TPI)	2,5mm	90°	Coarse	Description	MS-10-HS	MS-10-C	MDR-10-HS	MDR-10-C	MDL-10-HS	MDL-10-C	MF-10-HS	MF-10-C
				Tracking Data	31T / .0326"	31T / .0326"	26T / .0389"	26T / .0389"	26T / .0389"	26T / .0389"	26T / .0389"	26T / .0389"
				Full Faced	25303	25304	25369	-	25435	-	-	-
Beveled	25336	25337		25402	-	25468	-	-	-			
12 (TPI)	2,0mm	90°		Description	MS-12-HS	MS-12-C	MDR-12-HS	MDR-12-C	MDL-12-HS	MDL-12-C	MF-12-HS	MF-12-C
				Tracking Data	37T / .0273"	37T / .0273"	33T / .0306"	33T / .0306"	33T / .0306"	33T / .0306"	33T / .0306"	33T / .0306"
				Full Faced	25305	25306	25371	25372	25437	25438	-	-
Beveled	25338	25339		25404	25405	25470	25471	-	-			
14 (TPI)	1,8mm	90°		Description	MS-14-HS	MS-14-C	MDR-14-HS	MDR-14-C	MDL-14-HS	MDL-14-C	MF-14-HS	MF-14-C
				Tracking Data	44T / .0230"	44T / .0230"	46T / .0220"	46T / .0220"	46T / .0220"	46T / .0220"	46T / .0220"	46T / .0220"
				Full Faced	25307	25308	25373	25374	25439	25440	-	-
Beveled	25340	25341		25406	25407	25472	25473	-	-			
16 (TPI)	1,6mm	90°	Description	MS-16-HS	MS-16-C	MDR-16-HS	MDR-16-C	MDL-16-HS	MDL-16-C	MF-16-HS	MF-16-C	
			Tracking Data	50T / .0202"	50T / .0202"	45T / .0224"	45T / .0224"	45T / .0224"	45T / .0224"	45T / .0224"	45T / .0224"	
			Full Faced	25309	25310	25375	25376	25441	25442	-	-	
Beveled	25342	25343	25408	25409	25474	25475	-	-				
20 (TPI)	1,2mm	90°	Description	MS-20-HS	MS-20-C	MDR-20-HS	MDR-20-C	MDL-20-HS	MDL-20-C	MF-20-HS	MF-20-C	
			Tracking Data	61T / .0165"	61T / .0165"	54T / .0187"	54T / .0187"	54T / .0187"	54T / .0187"	54T / .0187"	54T / .0187"	
			Full Faced	25311	25312	25377	25378	25443	25444	-	-	
Beveled	-	25345	25410	25411	25476	25477	-	25543				
25 (TPI)	1,0mm	90°	Description	MS-25-HS	MS-25-C	MDR-25-HS	MDR-25-C	MDL-25-HS	MDL-25-C	MF-25-HS	MF-25-C	
			Tracking Data	78T / .0129"	78T / .0129"	68T / .0148"	68T / .0148"	68T / .0148"	68T / .0148"	68T / .0148"	68T / .0148"	
			Full Faced	25313	25314	25379	25380	25445	25446	-	-	
Beveled	25346	25347	25412	25413	25478	25479	-	-				
30 (TPI)	0,8mm	90°	Description	MS-30-HS	MS-30-C	MDR-30-HS	MDR-30-C	MDL-30-HS	MDL-30-C	MF-30-HS	MF-30-C	
			Tracking Data	95T / .0106"	95T / .0106"	81T / .0124"	81T / .0124"	81T / .0124"	81T / .0124"	81T / .0124"	81T / .0124"	
			Full Faced	25315	25316	25381	25382	25447	25448	25513	25514	
Beveled	25348	25349	25414	25415	25480	25481	-	25547				
35 (TPI)	0,7mm	90°	Description	MS-35-HS	MS-35-C	MDR-35-HS	MDR-35-C	MDL-35-HS	MDL-35-C	MF-35-HS	MF-35-C	
			Tracking Data	110T / .0091"	110T / .0091"	95T / .0106"	95T / .0106"	95T / .0106"	95T / .0106"	95T / .0106"	95T / .0106"	
			Full Faced	25317	25318	-	-	-	-	-	-	
Beveled	25350	-	-	-	-	-	-	-				
40 (TPI)	0,6mm	90°	Description	MS-40-HS	MS-40-C	MDR-40-HS	MDR-40-C	MDL-40-HS	MDL-40-C	MF-40-HS	MF-40-C	
			Tracking Data	124T / .0081"	124T / .0081"	108T / .0093"	108T / .0093"	108T / .0093"	108T / .0093"	108T / .0093"	108T / .0093"	
			Full Faced	-	-	-	-	-	-	-	-	
Beveled	-	-	-	-	-	-	-	-				
50 (TPI)	0,5mm	70°	Description	MS-50-HS	MS-50-C	MDR-50-HS	MDR-50-C	MDL-50-HS	MDL-50-C	MF-50-HS	MF-50-C	
			Tracking Data	158T / .0063"	158T / .0063"	135T / .0074"	135T / .0074"	135T / .0074"	135T / .0074"	135T / .0074"	135T / .0074"	
			Full Faced	25321	25322	-	-	-	-	-	-	
Beveled	-	-	-	-	-	-	-	-				
Diametral Pitch												
64	1,2mm	80°	Medium	Description	MS-64-HS	MS-64-C	MDR-64-HS	MDR-64-C	MDL-64-HS	MDL-64-C	MF-64-HS	MF-64-C
				Tracking Data	64T / .0156"	64T / .0156"	64T / .0156"	64T / .0156"	64T / .0156"	64T / .0156"	64T / .0156"	64T / .0156"
				Full Faced	25323	25324	-	-	-	-	-	-
Beveled	25356	25357		-	-	-	-	-	-			
96	0,8mm	80°		Description	MS-96-HS	MS-96-C	MDR-96-HS	MDR-96-C	MDL-96-HS	MDL-96-C	MF-96-HS	MF-96-C
				Tracking Data	96T / .0104"	96T / .0104"	96T / .0104"	96T / .0104"	96T / .0104"	96T / .0104"	96T / .0104"	96T / .0104"
				Full Faced	25325	25326	-	25392	-	25458	25523	-
Beveled	25358	25359		25424	25425	25490	25491	-	-			
128	0,6mm	80°		Description	MS-128-HS	MS-128-C	MDR-128-HS	MDR-128-C	MDL-128-HS	MDL-128-C	MF-128-HS	MF-128-C
				Tracking Data	128T / .0078"	128T / .0078"	128T / .0078"	128T / .0078"	128T / .0078"	128T / .0078"	128T / .0078"	128T / .0078"
				Full Faced	-	-	-	-	-	-	-	-
Beveled	25360	-		-	-	-	-	-	-			

O Series

For knurl cutting, use full faced knurl wheels only.
 For end-feed form knurling, use beveled knurl wheels only.
 For in-feed form knurling, beveled or full faced may be used.
 Knurl wheels can be reversed for right or left hand operation.

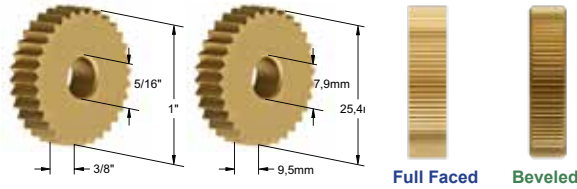

Knurl wheels are TiN coated to reduce the coefficient of friction when knurling, increasing the quality and the force of knurling as well as the life of the knurl wheels.

Circular Knurl Pitch		Included Tooth Angle	Knurl Pattern	O Series Knurl Wheel	Straight		Diagonal Right		Diagonal Left		Diamond	
Inch	Metric				High Speed TiN Coated	Cobalt TiN Coated	High Speed TiN Coated	Cobalt TiN Coated	High Speed TiN Coated	Cobalt TiN Coated	Male High Speed TiN Coated	Female High Speed TiN Coated
10 (TPI)	2,5mm	90°	Coarse	Description	OS-10-HS	OS-10-C	ODR-10-HS	ODR-10-C	ODL-10-HS	ODL-10-C	OM-10-HS	OF-10-HS
				Tracking Data	31T / .0326"	31T / .0326"	26T / .0389"	26T / .0389"	26T / .0389"	26T / .0389"	26T / .0389"	26T / .0389"
				Full Faced	25604	-	25736	-	25868	-	-	-
Beveled	-	-		-	-	-	-	-	-			
12 (TPI)	2,0mm	90°		Description	OS-12-HS	OS-12-C	ODR-12-HS	ODR-12-C	ODL-12-HS	ODL-12-C	OM-12-HS	OF-12-HS
				Tracking Data	37T / .0273"	37T / .0273"	33T / .0306"	33T / .0306"	33T / .0306"	33T / .0306"	33T / .0306"	33T / .0306"
				Full Faced	25606	-	-	-	25870	-	-	-
Beveled	-	-		25771	-	25903	-	-	-			
14 (TPI)	1,8mm	90°		Description	OS-14-HS	OS-14-C	ODR-14-HS	ODR-14-C	ODL-14-HS	ODL-14-C	OM-14-HS	OF-14-HS
				Tracking Data	44T / .0230"	44T / .0230"	46T / .0220"	46T / .0220"	46T / .0220"	46T / .0220"	46T / .0220"	46T / .0220"
				Full Faced	25608	25674	-	-	-	-	-	-
Beveled	25641	25707		-	25839	-	25971	-	-			
16 (TPI)	1,6mm	90°	Description	OS-16-HS	OS-16-C	ODR-16-HS	ODR-16-C	ODL-16-HS	ODL-16-C	OM-16-HS	OF-16-HS	
			Tracking Data	50T / .0202"	50T / .0202"	45T / .0224"	45T / .0224"	45T / .0224"	45T / .0224"	45T / .0224"	45T / .0224"	
			Full Faced	25610	25676	25742	-	25874	-	-	-	
Beveled	25643	25709	-	-	-	-	-	-				
20 (TPI)	1,2mm	90°	Description	OS-20-HS	OS-20-C	ODR-20-HS	ODR-20-C	ODL-20-HS	ODL-20-C	OM-20-HS	OF-20-HS	
			Tracking Data	61T / .0165"	61T / .0165"	54T / .0187"	54T / .0187"	54T / .0187"	54T / .0187"	54T / .0187"	54T / .0187"	
			Full Faced	25612	25678	-	-	-	-	26008	26074	
Beveled	25645	25711	25777	-	25909	-	-	26107				
25 (TPI)	1,0mm	90°	Description	OS-25-HS	OS-25-C	ODR-25-HS	ODR-25-C	ODL-25-HS	ODL-25-C	OM-25-HS	OF-25-HS	
			Tracking Data	78T / .0129"	78T / .0129"	68T / .0148"	68T / .0148"	68T / .0148"	68T / .0148"	68T / .0148"	68T / .0148"	
			Full Faced	25614	25680	-	25812	-	25944	26010	26076	
Beveled	25647	25713	25779	25845	25911	25977	26043	26109				
30 (TPI)	0,8mm	90°	Description	OS-30-HS	OS-30-C	ODR-30-HS	ODR-30-C	ODL-30-HS	ODL-30-C	OM-30-HS	OF-30-HS	
			Tracking Data	95T / .0106"	95T / .0106"	81T / .0124"	81T / .0124"	81T / .0124"	81T / .0124"	81T / .0124"	81T / .0124"	
			Full Faced	25616	25682	-	-	-	-	26012	26078	
Beveled	25649	-	-	-	-	-	-	26111				
35 (TPI)	0,7mm	90°	Description	OS-35-HS	OS-35-C	ODR-35-HS	ODR-35-C	ODL-35-HS	ODL-35-C	OM-35-HS	OF-35-HS	
			Tracking Data	110T / .0091"	110T / .0091"	95T / .0106"	95T / .0106"	95T / .0106"	95T / .0106"	95T / .0106"	95T / .0106"	
			Full Faced	25618	25684	-	-	-	-	-	-	
Beveled	-	-	-	-	-	-	-	-				
40 (TPI)	0,6mm	90°	Description	OS-40-HS	OS-40-C	ODR-40-HS	ODR-40-C	ODL-40-HS	ODL-40-C	OM-40-HS	OF-40-HS	
			Tracking Data	124T / .0081"	124T / .0081"	108T / .0093"	108T / .0093"	108T / .0093"	108T / .0093"	108T / .0093"	108T / .0093"	
			Full Faced	-	-	-	-	-	-	-	-	
Beveled	-	-	-	-	-	-	-	-				
50 (TPI)	0,5mm	70°	Description	OS-50-HS	OS-50-C	ODR-50-HS	ODR-50-C	ODL-50-HS	ODL-50-C	OM-50-HS	OF-50-HS	
			Tracking Data	158T / .0063"	158T / .0063"	135T / .0074"	135T / .0074"	135T / .0074"	135T / .0074"	135T / .0074"	135T / .0074"	
			Full Faced	-	-	-	-	-	-	-	-	
Beveled	-	-	-	-	-	-	-	-				
Diametral Pitch												
64	1,2mm	80°	Medium	Description	OS-64-HS	OS-64-C	ODR-64-HS	ODR-64-C	ODL-64-HS	ODL-64-C	OM-64-HS	OF-64-HS
				Tracking Data	64T / .0156"	64T / .0156"	64T / .0156"	64T / .0156"	64T / .0156"	64T / .0156"	64T / .0156"	64T / .0156"
				Full Faced	25624	-	-	-	-	-	-	-
Beveled	25657	-		-	-	-	-	-	-			
96	0,8mm	80°		Description	OS-96-HS	OS-96-C	ODR-96-HS	ODR-96-C	ODL-96-HS	ODL-96-C	OM-96-HS	OF-96-HS
				Tracking Data	96T / .0104"	96T / .0104"	96T / .0104"	96T / .0104"	96T / .0104"	96T / .0104"	96T / .0104"	96T / .0104"
				Full Faced	25626	-	-	-	-	-	-	-
Beveled	25659	-		-	-	-	-	-	-			
128	0,6mm	80°		Description	OS-128-HS	OS-128-C	ODR-128-HS	ODR-128-C	ODL-128-HS	ODL-128-C	OM-128-HS	OF-128-HS
				Tracking Data	128T / .0078"	128T / .0078"	128T / .0078"	128T / .0078"	128T / .0078"	128T / .0078"	128T / .0078"	128T / .0078"
				Full Faced	-	25694	-	-	-	-	-	-
Beveled	-	-		-	-	-	-	-	-			

P Series

For knurl cutting, use full faced knurl wheels only.

For end-feed form knurling, use beveled knurl wheels only.

For in-feed form knurling, beveled or full faced may be used.

Knurl wheels can be reversed for right or left hand operation.

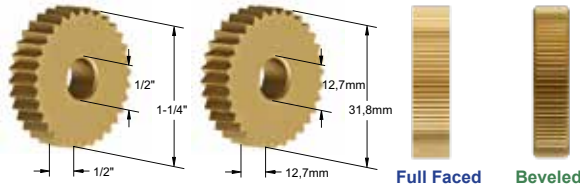

Knurl wheels are TiN coated to reduce the coefficient of friction when knurling, increasing the quality and the force of knurling as well as the life of the knurl wheels.

Circular Knurl Pitch		Included Tooth Angle	Knurl Pattern	P Series Knurl Wheel	Straight		Diagonal Right		Diagonal Left		Diamond	
Inch	Metric				High Speed TiN Coated	Cobalt TiN Coated	High Speed TiN Coated	Cobalt TiN Coated	High Speed TiN Coated	Cobalt TiN Coated	Male High Speed TiN Coated	Female High Speed TiN Coated
10 (TPI)	2,5mm	90°	Coarse	Description	PS-10-HS	PS-10-C	PDR-10-HS	PDR-10-C	PDL-10-HS	PDL-10-C	PM-10-HS	PF-10-HS
				Tracking Data	39T / .0323"	39T / .0323"	34T / .0371"	34T / .0371"	34T / .0371"	34T / .0371"	34T / .0371"	34T / .0371"
				Full Faced	-	-	-	-	-	-	-	-
Beveled	26215	-		-	-	-	-	-	-			
12 (TPI)	2,0mm	90°		Description	PS-12-HS	PS-12-C	PDR-12-HS	PDR-12-C	PDL-12-HS	PDL-12-C	PM-12-HS	PF-12-HS
				Tracking Data	47T / .0268"	47T / .0268"	41T / .0307"	41T / .0307"	41T / .0307"	41T / .0307"	41T / .0307"	41T / .0307"
				Full Faced	-	-	26268	-	26336	-	26404	-
Beveled	26217	-		26285	-	26353	-	-	-			
14 (TPI)	1,8mm	90°		Description	PS-14-HS	PS-14-C	PDR-14-HS	PDR-14-C	PDL-14-HS	PDL-14-C	PM-14-HS	PF-14-HS
				Tracking Data	55T / .0229"	55T / .0229"	55T / .0229"	55T / .0229"	55T / .0229"	55T / .0229"	55T / .0229"	55T / .0229"
				Full Faced	26202	-	-	-	-	-	-	-
Beveled	-	-		-	-	-	-	-	-			
16 (TPI)	1,6mm	90°	Description	PS-16-HS	PS-16-C	PDR-16-HS	PDR-16-C	PDL-16-HS	PDL-16-C	PM-16-HS	PF-16-HS	
			Tracking Data	63T / .0200"	63T / .0200"	53T / .0238"	53T / .0238"	53T / .0238"	53T / .0238"	53T / .0238"	53T / .0238"	
			Full Faced	-	26238	-	-	-	26408	26442	-	
Beveled	-	-	-	26323	-	26391	-	26459				
20 (TPI)	1,2mm	90°	Description	PS-20-HS	PS-20-C	PDR-20-HS	PDR-20-C	PDL-20-HS	PDL-20-C	PM-20-HS	PF-20-HS	
			Tracking Data	79T / .0159"	79T / .0159"	68T / .0185"	68T / .0185"	68T / .0185"	68T / .0185"	68T / .0185"	68T / .0185"	
			Full Faced	-	26240	26274	-	26342	-	26410	-	
Beveled	-	26257	-	-	-	-	26427	-				
25 (TPI)	1,0mm	90°	Description	PS-25-HS	PS-25-C	PDR-25-HS	PDR-25-C	PDL-25-HS	PDL-25-C	PM-25-HS	PF-25-HS	
			Tracking Data	97T / .0130"	97T / .0130"	85T / .0148"	85T / .0148"	85T / .0148"	85T / .0148"	85T / .0148"	85T / .0148"	
			Full Faced	-	26242	-	-	-	-	-	26446	
Beveled	26225	26259	26293	-	26361	-	26429	-				
30 (TPI)	0,8mm	90°	Description	PS-30-HS	PS-30-C	PDR-30-HS	PDR-30-C	PDL-30-HS	PDL-30-C	PM-30-HS	PF-30-HS	
			Tracking Data	117T / .0107"	117T / .0107"	103T / .0122"	103T / .0122"	103T / .0122"	103T / .0122"	103T / .0122"	103T / .0122"	
			Full Faced	-	-	26278	-	26346	-	-	-	
Beveled	-	26261	-	-	-	-	-	-				
Diametral Pitch												
64	1,2mm	80°	Medium	Description	PS-64-HS	PS-64-C	PDR-64-HS	PDR-64-C	PDL-64-HS	PDL-64-C	PM-64-HS	PF-64-HS
				Tracking Data	81T / .0156"	81T / .0156"	81T / .0156"	81T / .0156"	81T / .0156"	81T / .0156"	81T / .0156"	81T / .0156"
				Full Faced	-	-	-	-	-	-	-	-
Beveled	-	-		-	-	-	-	-	-			
96	0,8mm	80°		Description	PS-96-HS	PS-96-C	PDR-96-HS	PDR-96-C	PDL-96-HS	PDL-96-C	PM-96-HS	PF-96-HS
				Tracking Data	121T / .0104"	121T / .0104"	121T / .0104"	121T / .0104"	121T / .0104"	121T / .0104"	121T / .0104"	121T / .0104"
				Full Faced	-	26248	26282	-	26350	-	-	-
Beveled	-	26265		-	-	-	-	-	-			

R Series

For knurl cutting, use full faced knurl wheels only.
 For end-feed form knurling, use beveled knurl wheels only.
 For in-feed form knurling, beveled or full faced may be used.
 Knurl wheels can be reversed for right or left hand operation.

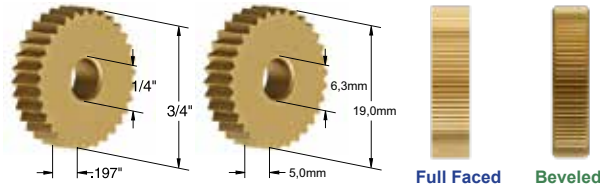

Knurl wheels are TIN coated to reduce the coefficient of friction when knurling, increasing the quality and the force of knurling as well as the life of the knurl wheels.

Circular Knurl Pitch		Included Tooth Angle	Knurl Pattern	R Series Knurl Wheel	Straight		Diagonal Right		Diagonal Left		Diamond	
Inch	Metric				High Speed TiN Coated	Cobalt TiN Coated	High Speed TiN Coated	Cobalt TiN Coated	High Speed TiN Coated	Cobalt TiN Coated	Female High Speed TiN Coated	Female Cobalt TiN Coated
10 (TPI)	2,5mm	90°	Coarse	Description	RS-10-HS	RS-10-C	RDR-10-HS	RDR-10-C	RDL-10-HS	RDL-10-C	RF-10-HS	RF-10-C
				Tracking Data	23T / .0330"	23T / .0330"	20T / .0380"	20T / .0380"	20T / .0380"	20T / .0380"	20T / .0380"	20T / .0380"
				Full Faced	26501	26502	26563	26564	26625	26626	-	-
Beveled	26532	-		-	-	-	-	-	-			
12 (TPI)	2,0mm	90°		Description	RS-12-HS	RS-12-C	RDR-12-HS	RDR-12-C	RDL-12-HS	RDL-12-C	RF-12-HS	RF-12-C
				Tracking Data	28T / .0271"	28T / .0271"	25T / .0304"	25T / .0304"	25T / .0304"	25T / .0304"	25T / .0304"	25T / .0304"
				Full Faced	26503	26504	-	26566	-	26628	-	-
Beveled	-	26535		-	-	-	-	-	-			
14 (TPI)	1,8mm	90°		Description	RS-14-HS	RS-14-C	RDR-14-HS	RDR-14-C	RDL-14-HS	RDL-14-C	RF-14-HS	RF-14-C
				Tracking Data	34T / .0224"	34T / .0224"	34T / .0224"	34T / .0224"	34T / .0224"	34T / .0224"	34T / .0224"	34T / .0224"
				Full Faced	26505	26506	26567	26568	26629	26630	-	-
Beveled	26536	26537		-	-	-	-	-	-			
16 (TPI)	1,6mm	90°	Description	RS-16-HS	RS-16-C	RDR-16-HS	RDR-16-C	RDL-16-HS	RDL-16-C	RF-16-HS	RF-16-C	
			Tracking Data	38T / .0200"	38T / .0200"	33T / .0230"	33T / .0230"	33T / .0230"	33T / .0230"	33T / .0230"	33T / .0230"	
			Full Faced	26507	26508	26569	-	26631	-	-	-	
Beveled	26538	26539	-	-	-	-	-	-				
20 (TPI)	1,2mm	90°	Description	RS-20-HS	RS-20-C	RDR-20-HS	RDR-20-C	RDL-20-HS	RDL-20-C	RF-20-HS	RF-20-C	
			Tracking Data	47T / .0161"	47T / .0161"	41T / .0185"	41T / .0185"	41T / .0185"	41T / .0185"	41T / .0185"	41T / .0185"	
			Full Faced	26509	26510	26571	26572	26633	26634	-	-	
Beveled	26540	26541	-	26603	-	26665	-	-				
25 (TPI)	1,0mm	90°	Description	RS-25-HS	RS-25-C	RDR-25-HS	RDR-25-C	RDL-25-HS	RDL-25-C	RF-25-HS	RF-25-C	
			Tracking Data	59T / .0128"	59T / .0128"	51T / .0148"	51T / .0148"	51T / .0148"	51T / .0148"	51T / .0148"	51T / .0148"	
			Full Faced	26511	26512	26573	26574	26635	26636	26697	-	
Beveled	26542	26543	26604	-	26666	-	-	-				
30 (TPI)	0,8mm	90°	Description	RS-30-HS	RS-30-C	RDR-30-HS	RDR-30-C	RDL-30-HS	RDL-30-C	RF-30-HS	RF-30-C	
			Tracking Data	71T / .0106"	71T / .0106"	61T / .0124"	61T / .0124"	61T / .0124"	61T / .0124"	61T / .0124"	61T / .0124"	
			Full Faced	26513	26514	26575	26576	26637	26638	-	-	
Beveled	26544	26545	26606	26607	26668	26669	-	26731				
35 (TPI)	0,7mm	90°	Description	RS-35-HS	RS-35-C	RDR-35-HS	RDR-35-C	RDL-35-HS	RDL-35-C	RF-35-HS	RF-35-C	
			Tracking Data	82T / .0092"	82T / .0092"	71T / .0106"	71T / .0106"	71T / .0106"	71T / .0106"	71T / .0106"	71T / .0106"	
			Full Faced	26515	26516	-	-	-	-	-	-	
Beveled	-	26547	26608	-	26670	-	-	-				
40 (TPI)	0,6mm	90°	Description	RS-40-HS	RS-40-C	RDR-40-HS	RDR-40-C	RDL-40-HS	RDL-40-C	RF-40-HS	RF-40-C	
			Tracking Data	94T / .0080"	94T / .0080"	81T / .0093"	81T / .0093"	81T / .0093"	81T / .0093"	81T / .0093"	81T / .0093"	
			Full Faced	26517	26518	26579	26580	26641	26642	-	-	
Beveled	26548	-	-	26611	-	-	-	-				
50 (TPI)	0,5mm	70°	Description	RS-50-HS	RS-50-C	RDR-50-HS	RDR-50-C	RDL-50-HS	RDL-50-C	RF-50-HS	RF-50-C	
			Tracking Data	117T / .0064"	117T / .0064"	102T / .0074"	102T / .0074"	102T / .0074"	102T / .0074"	102T / .0074"	102T / .0074"	
			Full Faced	26519	26520	-	26582	-	26644	-	26706	
Beveled	-	-	26612	-	26674	-	-	-				
Diametral Pitch												
64	1,2mm	80°	Medium	Description	RS-64-HS	RS-64-C	RDR-64-HS	RDR-64-C	RDL-64-HS	RDL-64-C	RF-64-HS	RF-64-C
				Tracking Data	48T / .0156	48T / .0156	48T / .0156	48T / .0156	48T / .0156	48T / .0156	48T / .0156	48T / .0156
				Full Faced	26521	-	26583	-	26645	-	-	-
Beveled	-	-		-	-	-	-	-	-			
96	0,8mm	80°		Description	RS-96-HS	RS-96-C	RDR-96-HS	RDR-96-C	RDL-96-HS	RDL-96-C	RF-96-HS	RF-96-C
				Tracking Data	72T / .0104"	72T / .0104"	72T / .0104"	72T / .0104"	72T / .0104"	72T / .0104"	72T / .0104"	72T / .0104"
				Full Faced	26523	26524	-	26586	-	26648	-	-
Beveled	26554	26555		-	26617	-	26679	-	-			
128	0,6mm	80°		Description	RS-128-HS	RS-128-C	RDR-128-HS	RDR-128-C	RDL-128-HS	RDL-128-C	RF-128-HS	RF-128-C
				Tracking Data	96T / .0078"	96T / .0078"	96T / .0078"	96T / .0078"	96T / .0078"	96T / .0078"	96T / .0078"	96T / .0078"
				Full Faced	-	26526	-	26588	-	26650	-	-
Beveled	-	-		-	-	-	-	-	-			
160	0,5mm	80°	Description	RS-160-HS	RS-160-C	RDR-160-HS	RDR-160-C	RDL-160-HS	RDL-160-C	RF-160-HS	RF-160-C	
			Tracking Data	120T / .0063"	120T / .0063"	120T / .0063"	120T / .0063"	120T / .0063"	120T / .0063"	120T / .0063"	120T / .0063"	
			Full Faced	-	-	-	-	-	-	-	-	
Beveled	-	-	-	-	-	-	-	-				

Knurl Wheels

S Series

For knurl cutting, use full faced knurl wheels only.

For end-feed form knurling, use beveled knurl wheels only.

For in-feed form knurling, beveled or full faced may be used.

Knurl wheels can be reversed for right or left hand operation.

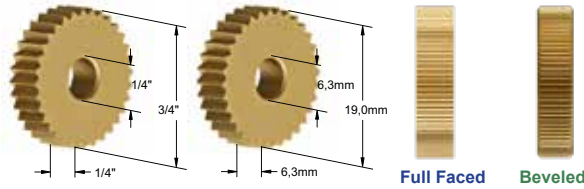

Knurl wheels are TiN coated to reduce the coefficient of friction when knurling, increasing the quality and the force of knurling as well as the life of the knurl wheels.

Circular Knurl Pitch		Included Tooth Angle	Knurl Pattern	S Series Knurl Wheel	Straight		Diagonal Right		Diagonal Left		Diamond	
Inch	Metric				High Speed TiN Coated	Cobalt TiN Coated	High Speed TiN Coated	Cobalt TiN Coated	High Speed TiN Coated	Cobalt TiN Coated	Male High Speed TiN Coated	Female High Speed TiN Coated
10 (TPI)	2,5mm	90°	Coarse	Description	SS-10-HS	SS-10-C	SDR-10-HS	SDR-10-C	SDL-10-HS	SDL-10-C	SM-10-HS	SF-10-HS
				Tracking Data	23T / .0330"	23T / .0330"	20T / .0380"	20T / .0380"	20T / .0380"	20T / .0380"	20T / .0380"	20T / .0380"
Full Faced	-	26862		26924	-	27048	-	-	-			
Beveled	-	-		-	-	-	-	-	-			
12 (TPI)	2,0mm	90°		Description	SS-12-HS	SS-12-C	SDR-12-HS	SDR-12-C	SDL-12-HS	SDL-12-C	SM-12-HS	SF-12-HS
				Tracking Data	28T / .0271"	28T / .0271"	25T / .0304"	25T / .0304"	25T / .0304"	25T / .0304"	25T / .0304"	25T / .0304"
Full Faced	26804	26864		26926	-	27050	-	-	-			
Beveled	-	26895		-	-	-	-	-	-			
14 (TPI)	1,8mm	90°		Description	SS-14-HS	SS-14-C	SDR-14-HS	SDR-14-C	SDL-14-HS	SDL-14-C	SM-14-HS	SF-14-HS
				Tracking Data	34T / .0224"	34T / .0224"	34T / .0224"	34T / .0224"	34T / .0224"	34T / .0224"	34T / .0224"	34T / .0224"
Full Faced	26806	-	-	-	-	-	-	-				
Beveled	-	-	26959	-	27083	-	-	-				
16 (TPI)	1,6mm	90°	Description	SS-16-HS	SS-16-C	SDR-16-HS	SDR-16-C	SDL-16-HS	SDL-16-C	SM-16-HS	SF-16-HS	
			Tracking Data	38T / .0200"	38T / .0200"	33T / .0230"	33T / .0230"	33T / .0230"	33T / .0230"	33T / .0230"	33T / .0230"	
Full Faced	26808	26868	-	-	-	-	27178	-				
Beveled	-	-	-	-	-	-	-	-				
20 (TPI)	1,2mm	90°	Description	SS-20-HS	SS-20-C	SDR-20-HS	SDR-20-C	SDL-20-HS	SDL-20-C	SM-20-HS	SF-20-HS	
			Tracking Data	47T / .0161"	47T / .0161"	41T / .0185"	41T / .0185"	41T / .0185"	41T / .0185"	41T / .0185"	41T / .0185"	
Full Faced	26810	26870	-	26994	-	27118	-	-				
Beveled	26841	-	-	-	-	-	-	-				
25 (TPI)	1,0mm	90°	Description	SS-25-HS	SS-25-C	SDR-25-HS	SDR-25-C	SDL-25-HS	SDL-25-C	SM-25-HS	SF-25-HS	
			Tracking Data	59T / .0128"	59T / .0128"	51T / .0148"	51T / .0148"	51T / .0148"	51T / .0148"	51T / .0148"	51T / .0148"	
Full Faced	26812	26872	26934	-	27058	-	27182	-				
Beveled	26843	26903	26965	-	27089	-	-	-				
30 (TPI)	0,8mm	90°	Description	SS-30-HS	SS-30-C	SDR-30-HS	SDR-30-C	SDL-30-HS	SDL-30-C	SM-30-HS	SF-30-HS	
			Tracking Data	71T / .0106"	71T / .0106"	61T / .0124"	61T / .0124"	61T / .0124"	61T / .0124"	61T / .0124"	61T / .0124"	
Full Faced	26814	26874	26936	26998	27060	-	-	-				
Beveled	26845	26905	26967	-	-	-	-	-				
35 (TPI)	0,7mm	90°	Description	SS-35-HS	SS-35-C	SDR-35-HS	SDR-35-C	SDL-35-HS	SDL-35-C	SM-35-HS	SF-35-HS	
			Tracking Data	82T / .0092"	82T / .0092"	71T / .0106"	71T / .0106"	71T / .0106"	71T / .0106"	71T / .0106"	71T / .0106"	
Full Faced	26816	-	-	27000	-	27124	-	-				
Beveled	-	-	-	-	-	-	-	-				
40 (TPI)	0,6mm	90°	Description	SS-40-HS	SS-40-C	SDR-40-HS	SDR-40-C	SDL-40-HS	SDL-40-C	SM-40-HS	SF-40-HS	
			Tracking Data	94T / .0080"	94T / .0080"	81T / .0093"	81T / .0093"	81T / .0093"	81T / .0093"	81T / .0093"	81T / .0093"	
Full Faced	26818	-	-	-	-	-	-	27250				
Beveled	-	-	-	27033	-	27157	-	-				
50 (TPI)	0,5mm	70°	Description	SS-50-HS	SS-50-C	SDR-50-HS	SDR-50-C	SDL-50-HS	SDL-50-C	SM-50-HS	SF-50-HS	
			Tracking Data	117T / .0064"	117T / .0064"	102T / .0074"	102T / .0074"	102T / .0074"	102T / .0074"	102T / .0074"	102T / .0074"	
Full Faced	-	-	26942	27004	27066	27128	-	27252				
Beveled	-	-	-	-	-	-	-	-				
Diametral Pitch												
64	1,2mm	80°	Medium	Description	SS-64-HS	SS-64-C	SDR-64-HS	SDR-64-C	SDL-64-HS	SDL-64-C	SM-64-HS	SF-64-HS
				Tracking Data	48T / .0156"	48T / .0156"	48T / .0156"	48T / .0156"	48T / .0156"	48T / .0156"	48T / .0156"	48T / .0156"
Full Faced	26822	26882		-	-	27130	-	-	-			
Beveled	-	-		26975	-	27099	-	-	-			
96	0,8mm	80°		Description	SS-96-HS	SS-96-C	SDR-96-HS	SDR-96-C	SDL-96-HS	SDL-96-C	SM-96-HS	SF-96-HS
				Tracking Data	72T / .0104"	72T / .0104"	72T / .0104"	72T / .0104"	72T / .0104"	72T / .0104"	72T / .0104"	72T / .0104"
Full Faced	26824	26884		-	-	-	-	-	-			
Beveled	-	-		-	-	-	-	-	-			
128	0,6mm	80°		Description	SS-128-HS	SS-128-C	SDR-128-HS	SDR-128-C	SDL-128-HS	SDL-128-C	SM-128-HS	SF-128-HS
				Tracking Data	96T / .0078"	96T / .0078"	96T / .0078"	96T / .0078"	96T / .0078"	96T / .0078"	96T / .0078"	96T / .0078"
Full Faced	26826	-	-	-	-	-	-	27258				
Beveled	-	-	-	-	-	-	-	-				
160	0,5mm	80°	Description	SS-160-HS	SS-160-C	SDR-160-HS	SDR-160-C	SDL-160-HS	SDL-160-C	SM-160-HS	SF-160-HS	
			Tracking Data	120T / .0063"	120T / .0063"	120T / .0063"	120T / .0063"	120T / .0063"	120T / .0063"	120T / .0063"	120T / .0063"	
Full Faced	-	-	-	27012	-	27136	-	-				
Beveled	26859	-	-	-	-	-	-	-				

SW2 Series

For knurl cutting, use full faced knurl wheels only.
 For End Feed form knurling, use beveled knurl wheels only.
 For In Feed form knurling, beveled or full faced may be used.
 "SW" knurling wheels are technically designed to knurl against a square shoulder.
 With super precise workmanship, the wheels are made of heat treated High Speed and Cobalt steel to withstand severe knurling operation.

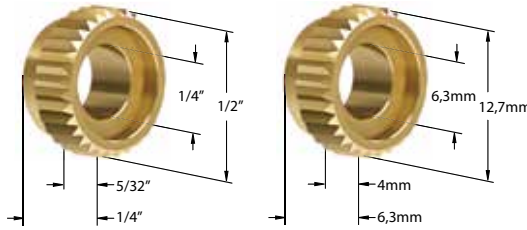

Knurl wheels are TIN coated to reduce the co-efficient of friction when knurling, increasing the quality and the force of knurling as well as the life of the knurl wheels.



Full Faced Beveled

Circular Knurl Pitch		Included Tooth Angle	Knurl Pattern	SW2 Series Knurl Wheel	Straight		Diagonal Right		Diagonal Left		Diamond	
Inch	Metric				High Speed TiN Coated	Cobalt TiN Coated	High Speed TiN Coated	Cobalt TiN Coated	High Speed TiN Coated	Cobalt TiN Coated	Female High Speed TiN Coated	Female Cobalt TiN Coated
16 (TPI)	1,6mm	90°	Coarse	Description	SW2S-16-HS	SW2S-16-C	SW2R-16-HS	SW2R-16-C	SW2L-16-HS	SW2L-16-C	SW2F-16-HS	SW2F-16-C
				Tracking Data	25T / .0204"	25T / .0204"	22T / .0232"	22T / .0232"	22T / .0232"	22T / .0232"	22T / .0232"	22T / .0232"
				Full Faced	27401	27402	-	-	27501	-	27551	-
				Beveled	-	-	-	-	27526	-	-	-
20 (TPI)	1,2mm	90°	Medium	Description	SW2S-20-HS	SW2S-20-C	SW2R-20-HS	SW2R-20-C	SW2L-20-HS	SW2L-20-C	SW2F-20-HS	SW2F-20-C
				Tracking Data	31T / .0164"	31T / .0164"	27T / .0188"	27T / .0188"	27T / .0188"	27T / .0188"	27T / .0188"	27T / .0188"
				Full Faced	27403	27404	27453	27454	27503	27504	-	-
				Beveled	27428	27429	27478	27479	27528	27529	-	-
25 (TPI)	1,0mm	90°	Medium	Description	SW2S-25-HS	SW2S-25-C	SW2R-25-HS	SW2R-25-C	SW2L-25-HS	SW2L-25-C	SW2F-25-HS	SW2F-25-C
				Tracking Data	38T / .0133"	38T / .0133"	34T / .0149"	34T / .0149"	34T / .0149"	34T / .0149"	34T / .0149"	34T / .0149"
				Full Faced	27405	27406	-	-	27505	27506	27555	-
				Beveled	27430	27431	27480	27481	27530	27531	-	-
30 (TPI)	0,8mm	90°	Medium	Description	SW2S-30-HS	SW2S-30-C	SW2R-30-HS	SW2R-30-C	SW2L-30-HS	SW2L-30-C	SW2F-30-HS	SW2F-30-C
				Tracking Data	47T / .0107"	47T / .0107"	40T / .0126"	40T / .0126"	40T / .0126"	40T / .0126"	40T / .0126"	40T / .0126"
				Full Faced	27407	27408	27457	27458	27507	27508	27557	-
				Beveled	27432	27433	27482	27483	27532	27533	-	-
35 (TPI)	0,7mm	90°	Fine	Description	SW2S-35-HS	SW2S-35-C	SW2R-35-HS	SW2R-35-C	SW2L-35-HS	SW2L-35-C	SW2F-35-HS	SW2F-35-C
				Tracking Data	55T / .0092"	55T / .0092"	47T / .0107"	47T / .0107"	47T / .0107"	47T / .0107"	47T / .0107"	47T / .0107"
				Full Faced	-	27410	27459	-	27509	-	-	-
				Beveled	-	27435	-	-	-	-	-	
40 (TPI)	0,6mm	90°	Fine	Description	SW2S-40-HS	SW2S-40-C	SW2R-40-HS	SW2R-40-C	SW2L-40-HS	SW2L-40-C	SW2F-40-HS	SW2F-40-C
				Tracking Data	63T / .0080"	63T / .0080"	55T / .0092"	55T / .0092"	55T / .0092"	55T / .0092"	55T / .0092"	55T / .0092"
				Full Faced	27411	27412	-	-	-	-	27561	-
				Beveled	-	27437	-	-	-	-	-	
50 (TPI)	0,5mm	70°	Fine	Description	SW2S-50-HS	SW2S-50-C	SW2R-50-HS	SW2R-50-C	SW2L-50-HS	SW2L-50-C	SW2F-50-HS	SW2F-50-C
				Tracking Data	79T / .0064"	79T / .0064"	68T / .0074"	68T / .0074"	68T / .0074"	68T / .0074"	68T / .0074"	68T / .0074"
				Full Faced	-	-	-	-	-	-	27563	-
				Beveled	-	27439	-	-	-	-	-	
Diametral Pitch												
64	1,2mm	80°	Medium	Description	SW2S-64-HS	SW2S-64-C	SW2R-64-HS	SW2R-64-C	SW2L-64-HS	SW2L-64-C	SW2F-64-HS	SW2F-64-C
				Tracking Data	32T / .0156"	32T / .0156"	32T / .0156"	32T / .0156"	32T / .0156"	32T / .0156"	32T / .0156"	32T / .0156"
				Full Faced	-	-	-	-	-	-	-	-
				Beveled	-	-	27490	-	27540	-	-	-
96	0,8mm	80°	Medium	Description	SW2S-96-HS	SW2S-96-C	SW2R-96-HS	SW2R-96-C	SW2L-96-HS	SW2L-96-C	SW2F-96-HS	SW2F-96-C
				Tracking Data	48T / .0104"	48T / .0104"	48T / .0104"	48T / .0104"	48T / .0104"	48T / .0104"	48T / .0104"	48T / .0104"
				Full Faced	27417	-	27467	27468	27517	27518	27567	-
				Beveled	27442	-	-	27493	-	27543	-	-
128	0,6mm	80°	Fine	Description	SW2S-128-HS	SW2S-128-C	SW2R-128-HS	SW2R-128-C	SW2L-128-HS	SW2L-128-C	SW2F-128-HS	SW2F-128-C
				Tracking Data	64T / .0078"	64T / .0078"	64T / .0078"	64T / .0078"	64T / .0078"	64T / .0078"	64T / .0078"	64T / .0078"
				Full Faced	27419	-	27469	-	27519	-	-	-
				Beveled	-	-	-	-	-	-	-	
160	0,5mm	80°	Fine	Description	SW2S-160-HS	SW2S-160-C	SW2R-160-HS	SW2R-160-C	SW2L-160-HS	SW2L-160-C	SW2F-160-HS	SW2F-160-C
				Tracking Data	80T / .0063"	80T / .0063"	80T / .0063"	80T / .0063"	80T / .0063"	80T / .0063"	80T / .0063"	80T / .0063"
				Full Faced	-	-	-	-	-	-	-	-
				Beveled	-	-	-	-	-	-	-	

SW4 Series

For knurl cutting, use full faced knurl wheels only.

For end-feed form knurling, use beveled knurl wheels only.

For in-feed form knurling, beveled or full faced may be used.

"SW" Knurl Wheels are technically designed to knurl against a square shoulder.

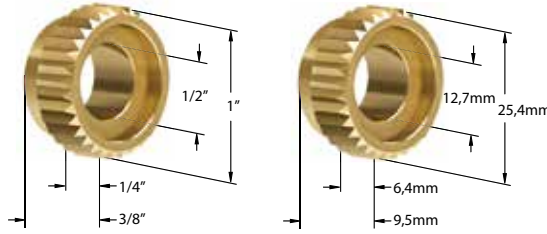

Knurl wheels are TIN coated to reduce the coefficient of friction when knurling, increasing the quality and the force of knurling as well as the life of the knurl wheels.



Full Faced Beveled

Circular Knurl Pitch		Included Tooth Angle	Knurl Pattern	SW4 Series Knurl Wheel	Straight		Diagonal Right		Diagonal Left		Diamond	
Inch	Metric				High Speed TIN Coated	Cobalt TIN Coated	High Speed TIN Coated	Cobalt TIN Coated	High Speed TIN Coated	Cobalt TIN Coated	Female High Speed TIN Coated	Female Cobalt TIN Coated
14 (TPI)	1,8mm	90°	Coarse	Description	SW4S-14-HS	SW4S-14-C	SW4R-14-HS	SW4R-14-C	SW4L-14-HS	SW4L-14-C	SW4F-14-HS	SW4F-14-C
				Tracking Data	44T / .0230"	44T / .0230"	38T / .0266"	38T / .0266"	38T / .0266"	38T / .0266"	38T / .0266"	38T / .0266"
Full Faced	28001	28002		28055	28056	28109	28110	28163	-			
Beveled	28028	28029		28082	28083	28136	28137	-	-			
16 (TPI)	1,6mm	90°		Description	SW4S-16-HS	SW4S-16-C	SW4R-16-HS	SW4R-16-C	SW4L-16-HS	SW4L-16-C	SW4F-16-HS	SW4F-16-C
				Tracking Data	50T / .0202"	50T / .0202"	45T / .0224"	45T / .0224"	45T / .0224"	45T / .0224"	45T / .0224"	45T / .0224"
Standard	28003	28004	28057	28058	28111	28112	28165	28166				
Bevel	28030	28031	28084	28085	28138	28139	-	28193				
20 (TPI)	1,2mm	90°	Description	SW4S-20-HS	SW4S-20-C	SW4R-20-HS	SW4R-20-C	SW4L-20-HS	SW4L-20-C	SW4F-20-HS	SW4F-20-C	
			Tracking Data	61T / .0165"	61T / .0165"	54T / .0187"	54T / .0187"	54T / .0187"	54T / .0187"	54T / .0187"	54T / .0187"	
Full Faced	28005	28006	28059	28060	28113	28114	28167	28168				
Beveled	28032	28033	28086	28087	28140	28141	-	28195				
25 (TPI)	1,0mm	90°	Description	SW4S-25-HS	SW4S-25-C	SW4R-25-HS	SW4R-25-C	SW4L-25-HS	SW4L-25-C	SW4F-25-HS	SW4F-25-C	
			Tracking Data	78T / .0129"	78T / .0129"	68T / .0148"	68T / .0148"	68T / .0148"	68T / .0148"	68T / .0148"	68T / .0148"	
Full Faced	28007	28008	28061	28062	28115	28116	-	-				
Beveled	28034	28035	28088	28089	28142	28143	-	-				
30 (TPI)	0,8mm	90°	Description	SW4S-30-HS	SW4S-30-C	SW4R-30-HS	SW4R-30-C	SW4L-30-HS	SW4L-30-C	SW4F-30-HS	SW4F-30-C	
			Tracking Data	95T / .0106"	95T / .0106"	81T / .0124"	81T / .0124"	81T / .0124"	81T / .0124"	81T / .0124"	81T / .0124"	
Full Faced	28009	28010	28063	28064	28117	28118	-	-				
Beveled	28036	28037	28090	28091	28144	28145	-	-				
35 (TPI)	0,7mm	90°	Description	SW4S-35-HS	SW4S-35-C	SW4R-35-HS	SW4R-35-C	SW4L-35-HS	SW4L-35-C	SW4F-35-HS	SW4F-35-C	
			Tracking Data	110T / .0091"	110T / .0091"	95T / .0106"	95T / .0106"	95T / .0106"	95T / .0106"	95T / .0106"	95T / .0106"	
Full Faced	-	28012	-	28066	-	28120	-	-				
Beveled	-	-	-	28093	-	28147	-	-				
40 (TPI)	0,6mm	90°	Description	SW4S-40-HS	SW4S-40-C	SW4R-40-HS	SW4R-40-C	SW4L-40-HS	SW4L-40-C	SW4F-40-HS	SW4F-40-C	
			Tracking Data	124T / .0081"	124T / .0081"	108T / .0093"	108T / .0093"	108T / .0093"	108T / .0093"	108T / .0093"	108T / .0093"	
Full Faced	28013	28014	-	28068	-	28122	-	-				
Beveled	28040	28041	-	-	-	-	-	-				
50 (TPI)	0,5mm	70°	Description	SW4S-50-HS	SW4S-50-C	SW4R-50-HS	SW4R-50-C	SW4L-50-HS	SW4L-50-C	SW4F-50-HS	SW4F-50-C	
			Tracking Data	158T / .0063"	158T / .0063"	135T / .0074"	135T / .0074"	135T / .0074"	135T / .0074"	135T / .0074"	135T / .0074"	
Standard	-	-	-	28070	-	28124	-	-				
Bevel	-	-	-	-	-	-	-	-				
Diametral Pitch												
64	1,2mm	80°	Medium	Description	SW4S-64-HS	SW4S-64-C	SW4R-64-HS	SW4R-64-C	SW4L-64-HS	SW4L-64-C	SW4F-64-HS	SW4F-64-C
				Tracking Data	64T / .0156"	64T / .0156"	64T / .0156"	64T / .0156"	64T / .0156"	64T / .0156"	64T / .0156"	64T / .0156"
Full Faced	28017	28018		-	-	-	-	-	-			
Beveled	28044	28045		-	-	-	-	-	-			
96	0,8mm	80°		Description	SW4S-96-HS	SW4S-96-C	SW4R-96-HS	SW4R-96-C	SW4L-96-HS	SW4L-96-C	SW4F-96-HS	SW4F-96-C
				Tracking Data	96T / .0104"	96T / .0104"	96T / .0104"	96T / .0104"	96T / .0104"	96T / .0104"	96T / .0104"	96T / .0104"
Full Faced	28019	28020	-	28074	-	28128	-	28181				
Beveled	28046	28047	-	28101	-	28155	-	-				

CNC Modular Knurling Tool Adjustment Screw

Description	UPC #	Reference Knurling Tool
CNC-1175	28505	CNC Modular Knurling Tool
SCNC-875	28510	SCNC Modular Knurling Tool

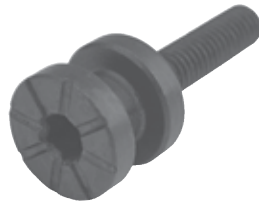

CNC Modular Knurling Tool Lock Screw

Description	UPC #	Reference Knurling Tool
CNC-1024*	28515	CNC Modular Knurling Tool
SCNC-832	28520	SCNC Modular Knurling Tool



*Set of three (3) lock screws

Spring & Ball Plunger For Self-Centering Knurl Tools

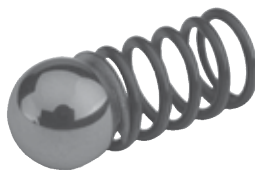

Description	UPC #	Reference Knurling Tool
STBL-18	28525	3SHKT-50-D, 3SHKT-162-D 3SHKT-12-D, 3SHKT-162-D SCKN-38-DW-D, SCKN-50-DWD, SCKN-162-DW-D SCKN-10-DW-D, SCKN-12-DWD, SCKN-162-DW-D SSCK-38-DW-2, SSCK-50-DW-2, SSCK-162-DW-2 SSCK-10-DW-2, SSCK-12-DW-2, SSCK-162-DW-2
STBL-25	28530	3SHKT-75-M, 3SHKT-100-M, 3SHKT-125-M 3SHKT-20-M, 3SHKT-25-M, 3SHKT-32-M SCKN-75-DW-M, SCKN-100-DW-M, SCKN-125-DW-M HDSCKN-75-DW-O, HDSCKN-100-DW-O, HDSCKN-100-DW-P, HDSCKN-125-DW-P SCKN-20-DW-M, SCKN-25-DW-M, SCKN-32-DW-M HDSCKN-20-DW-O, HDSCKN-25-DW-O, HDSCKN-25-DW-P, HDSCKN-32-DW-P SSCK-75-DW-4, SSCK-100-DW-4, SSCK-125-DW-4 SSCK-20-DW-4, SSCK-25-DW-4, SSCK-32-DW-4

KPS Series Knurling Pin Set

High Speed		Carbide		D (inch)	L (inch)
Description	UPC #	Description	UPC #		
KPS-12-38	28800	KPS-12-38-C	28900	1/8	3/8
KPS-18-50	28805	KPS-18-50-C	28905	3/16	1/2
KPS-18-62	28810	KPS-18-62-C	28910	3/16	5/8
KPS-25-62	28815	KPS-25-62-C	28915	1/4	5/8
KPS-25-75	28820	KPS-25-75-C	28920	1/4	3/4
KPS-25-87	28825	KPS-25-87-C	28925	1/4	7/8
KPS-25-100	28830	KPS-25-100-C	28930	1/4	1.0
KPS-25-125	28835	KPS-25-125-C	28935	1/4	1-1/4
KPS-31-75	28840	KPS-31-75-C	28940	5/16	3/4
KPS-31-100	28845	KPS-31-100-C	28945	5/16	1.0
KPS-31-125	28850	KPS-31-125-C	28950	5/16	1-1/4
KPS-50-125	28855	KPS-50-125-C	28955	1/2	1-1/4
KPS-50-150	28860	KPS-50-150-C	28960	1/2	1-1/2



SW Series Knurling Pin Set

High Speed		D (inch)	L (inch)
Description	UPC #		
SW2.0P-1S*	29050	1/4	1/2
SW2.0P-2S**	29055		
SW2.0P-3S***	29060		
SW4.0P-1S*	29080	1/2	1-1/8
SW4.0P-2S**	29085		
SW4.0P-3S***	29090		

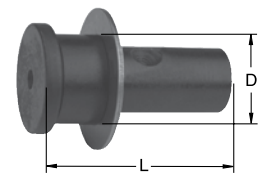

* Set of one (1) pin and washer
 ** Set of two (2) pins and washers
 *** Set of three (3) pins and washers

SW Series Knurling Pin Set Cobalt

Cobalt		D (inch)	L (inch)
Description	UPC #		
SW2.0P-CO-1S*	30003	1/4	1/2
SW2.0P-CO-2S**	30004		
SW2.0P-CO-3S***	30005		
SW4.0P-CO-1S*	30009	1/2	1-1/8
SW4.0P-CO-2S**	30010		
SW4.0P-CO-3S***	30011		

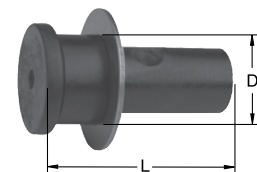

* Set of one (1) pin and washer
 ** Set of two (2) pins and washers
 *** Set of three (3) pins and washers

Linear Measurement

1 foot = 12 inches
1 yard = 3 feet
1 yard = 36 inches
1 mile = 1,760 yards
1 mile = 5,280 feet
1 mile = 63,360 inches
1 light year = 5.879 trillion miles

1 inch = 2.540 centimeters
1 foot = .3048 meters
1 yard = .9144 meters
1 mile = 1.609 kilometers
1 centimeter = .3937 inches
1 meter = 3.281 feet
1 meter = 1.094 yards
1 kilometer = .6214 miles

1 kilometer = 1000 meters
1 hectometer = 100 meters
1 dekameter = 10 meters
1 meter = 10 decimeters
1 meter = 100 centimeters
1 meter = 1000 millimeters
1 light year = 9.46 trillion kilometers

Square Measurement

1 sq. foot = 144 sq. inches
1 sq. yard = 9 sq. feet
1 sq. yard = 1,296 sq. inches
1 sq. mile = 3,097,600 sq. yards
1 sq. mile = 27,878,400 sq. feet
1 sq. mile = 4,014,489,600 sq. inches
1 acre = 4,840 sq. yards
1 acre = 43,560 sq. feet
1 acre = 6,272,640 sq. inches

1 sq. inch = 6.452 sq. centimeters
1 sq. foot = .09290 sq. meters
1 sq. yard = .8361 sq. meters
1 sq. mile = 2.590 sq. kilometers
1 sq. centimeter = .155 sq. inches
1 sq. kilometer = 247.1 acres
1 sq. kilometer = .3861 sq. miles
1 sq. meter = 10.76 sq. feet
1 sq. meter = 1.196 sq. yards

1 sq. kilometer = 1,000,000 sq. meters
1 sq. hectometer = 10,000 sq. meters
1 sq. dekameter = 100 sq. meters
1 sq. meter = 100 sq. decimeters
1 sq. meter = 10,000 sq. centimeters
1 sq. meter = 1,000,000 sq. millimeters

Cubic Measurement

1 cu. foot = 1,728 cu. inches
1 cu. yard = 27 cu. feet
1 cu. yard = 46,656 cu. inches

1 cu. inch = 16.39 cu. centimeters
1 cu. foot = 28,320 cu. centimeters
1 cu. foot = .02832 cu. meters
1 cu. yard = 764,600 cu. centimeters
1 cu. yard = .7646 cu. meters
1 cu. centimeter = .06102 cu. inches
1 cu. meter = 35.31 cu. feet
1 cu. meter = 61,023 cu. inches
1 cu. meter = 1.308 cu. yards

1 cu. kilometer = 1,000,000,000 cu. meters
1 cu. hectometer = 1,000,000 cu. meters
1 cu. dekameter = 1,000 cu. meters
1 cu. meter = 1,000 cu. decimeters
1 cu. meter = 1,000,000 cu. centimeters
1 cu. meter = 1,000,000,000 cu. millimeters

Weight Measurements

1 pound = 16 ounces
1 ton = 2000 pounds
1 ton = 32,000 ounces

1 ounce = 28.349527 grams
1 pound = .4536 kilograms
1 english ton = .90718 metric tons
1 gram = .03527 ounces
1 kilogram = 2.205 pounds
1 metric ton = .98421 english tons

1 kilogram = 1000 grams
1 hectogram = 100 grams
1 dekagram = 10 grams
1 gram = 10 decigrams
1 gram = 100 centigrams
1 gram = 1000 milligrams

Fluid Volume Measurements

1 gallon = 4 quarts
1 gallon = 8 pints
1 gallon = 16 cups
1 gallon = 256 liquid ounces
1 quart = 2 pints
1 quart = 4 cups
1 quart = 64 liquid ounces
1 pint = 2 cups
1 pint = 16 liquid ounces
1 cup = 8 liquid ounces

1 gallon = 3.785 liters

1 quart = .9463 liters
1 pint = .4732 liters
1 liter = .2642 gallons
1 liter = 1.057 quarts
1 liter = 2.113 pints

1 kiloliter = 1000 liters
1 hectoliter = 100 liters
1 dekaliter = 10 liters
1 liter = 10 deciliters
1 liter = 100 centiliters
1 liter = 1000 milliliters

Temperature Conversions

To convert Fahrenheit degrees into Celsius, subtract 32, multiply by .5556.

To convert Celsius into Fahrenheit, multiply by 1.8 and add 32.

Speeds

1 mile/hour = 88 feet/minute
1 mile/hour = 1.467 feet/second
1 mile/hour = 1.609 kilometers/hour
1 miles/hour = 44.70 centimeters/second
1 foot/minute = .0113636 miles/hour
1 foot/second = 30.48 centimeters/second
1 foot/second = .6818 miles/hour
1 centimeter/second = .3281 feet/second
speed of sound = 742 miles/hour in air
speed of sound = 1,193.9 kilometers/hour
speed of light = 186,295 miles/second
speed of light = 299,748 kilometers/second

Time

1 minute = 60 seconds
1 hour = 60 minutes
1 hour = 3,600 seconds
1 day = 24 hours
1 day = 1,440 minutes
1 day = 86,400 seconds
1 week = 7 days
1 week = 168 hours
1 week = 10,080 minutes
1 week = 604,800 seconds
1 year = 12 months
1 year = 52 weeks
1 year = 365 days 6 hours
1 year = 8,766 hours
1 year = 525,960 minutes
1 year = 31,557,600 seconds

From Inch to Metric Formula

Inch Value		Metric Value	
1.000	x	25.4	= 25.400
1.000	÷	0.03937	= 25.400

From Metric to Inch Formula

Metric Value		Inch Value	
1.000	÷	25.4	= 0.03937
1.000	x	0.03937	= 0.03937

From Inch to Metric Values

Inch			Millimeter		
0.00001	x	25.4	=	0.000254	
0.0001	x	25.4	=	0.00254	
0.001	x	25.4	=	0.0254	
0.01	x	25.4	=	0.254	
0.1	x	25.4	=	2.54	

From Metric to Inch Values

Millimeter			Inch		
0.00001	÷	25.4	=	0.00000039	
0.0001	÷	25.4	=	0.0000039	
0.001	÷	25.4	=	0.000039	
0.01	÷	25.4	=	0.00039	
0.1	÷	25.4	=	0.00394	

1.00	x	25.4	=	25.40
1.125	x	25.4	=	28.58
1.250	x	25.4	=	31.75
1.375	x	25.4	=	34.93
1.500	x	25.4	=	38.10
1.625	x	25.4	=	41.28
1.750	x	25.4	=	44.45
1.875	x	25.4	=	47.63
2.00	x	25.4	=	50.80
3.00	x	25.4	=	76.20
4.00	x	25.4	=	101.60
5.00	x	25.4	=	127.00
6.00	x	25.4	=	152.40
7.00	x	25.4	=	177.80
8.00	x	25.4	=	203.20
9.00	x	25.4	=	228.60
10.00	x	25.4	=	254.00

1	÷	25.4	=	0.0394
1.1	÷	25.4	=	0.0433
1.2	÷	25.4	=	0.0472
1.3	÷	25.4	=	0.0512
1.4	÷	25.4	=	0.0551
1.5	÷	25.4	=	0.0591
1.6	÷	25.4	=	0.0630
1.7	÷	25.4	=	0.0669
1.8	÷	25.4	=	0.0709
1.9	÷	25.4	=	0.0748
2	÷	25.4	=	0.0787
3	÷	25.4	=	0.1181
4	÷	25.4	=	0.1575
5	÷	25.4	=	0.1969
6	÷	25.4	=	0.2362
7	÷	25.4	=	0.2756
8	÷	25.4	=	0.3150
9	÷	25.4	=	0.3543
10	÷	25.4	=	0.3937

11.00	x	25.4	=	279.40
12.00	x	25.4	=	304.80
13.00	x	25.4	=	330.20
14.00	x	25.4	=	355.60
15.00	x	25.4	=	381.00
16.00	x	25.4	=	406.40
17.00	x	25.4	=	431.80
18.00	x	25.4	=	457.20
19.00	x	25.4	=	482.60
20.00	x	25.4	=	508.00
21.00	x	25.4	=	533.40
22.00	x	25.4	=	558.80
23.00	x	25.4	=	584.20
24.00	x	25.4	=	609.60
25.00	x	25.4	=	635.00

11	÷	25.4	=	0.4331
12	÷	25.4	=	0.4724
13	÷	25.4	=	0.5118
14	÷	25.4	=	0.5512
15	÷	25.4	=	0.5906
16	÷	25.4	=	0.6299
17	÷	25.4	=	0.6693
18	÷	25.4	=	0.7087
19	÷	25.4	=	0.7480
20	÷	25.4	=	0.7874
21	÷	25.4	=	0.8268
22	÷	25.4	=	0.8661
23	÷	25.4	=	0.9055
24	÷	25.4	=	0.9449
25	÷	25.4	=	0.9843

1-Foot	12.00	x	25.4	=	304.80
1-Yard	36.00	x	25.4	=	914.40

1-Meter	1000	÷	25.4	=	39.3701
1-Decimeter	100	÷	25.4	=	3.9370
1-Centimeter	10	÷	25.4	=	0.3937
1-Millimeter	1	÷	25.4	=	0.0394

Safety Precautions & Product Hazards

This catalog contains information and specifications concerning knurling tools sold by Dorian Tool International. Although some of the Knurl Wheels are made from cobalt, are very tough and resist breakage, most are brittle and special safety precautions are required when using them. Small fragment and chips may be thrown from a knurling tool when a fracture occurs. Since these fragments or chips are thrown at very high speeds and are very hot, contact with the skin or eyes could cause severe injury. Also, the grinding of these cutting tools will produce fine cobalt dust which may be harmful to the lungs. Listed below are some suggestions on how to minimize the potential for injury while using knurling tools. Dorian Tool has no control over use of these knurling tools. The user must determine the suitability of these tools in its particular application.

Warning: Very hot chip fragments may be thrown from knurling tools at very high speeds. These chips can cause severe burns, cuts or punctures to the skin, or damage to the eyes. Along with safety glasses with side shields, the following are some of the safety precautions that must be followed by operators and observers while using knurling tools:

1. Make sure that the wheel size and style are adequate for use to which it is being put.
2. Chip control is necessary to prevent a continuous chip catching in the workpiece.
3. Chips are very hot and have sharp edges and should not be moved by hand.
4. Turn off the machine whenever chips are removed or when the knurling tools are changed.
5. Do not use air hoses to blow chips away from the machine.
6. To prevent tool breakage, use the correct size toolholder.
7. Make sure that the overhang on the knurl tool is as short as possible. Too much overhang can result in chatter and tool breakage.
8. To prevent the workpiece from coming loose during use, be sure the workpiece is tight and secure in its holder.
9. Overloading of cobalt knurl wheels may cause fractures of these wheels.

Warning: Grinding or finishing cobalt produces fine cobalt dust. This dust may cause injury to the lungs. Operators and observers must take the following safety precautions to minimize the possibility of such injury:

1. Use with adequate ventilation.
2. Maintain the dust or mist level below OSHA and ACGIH levels.
3. Avoid breathing dust or mist. If not possible, wear OSHA - approved respirators, particularly when grinding cobalt.
4. Minimize prolonged skin contact.
5. Wash hands thoroughly after handling.

1. Keep the cutting fluid clean so no particles can be carried back across the workpiece and possibly scratch it.
2. Cutting fluids may catch on fire when exposed to high temperatures generated during knurling.
3. Work materials such as aluminum, magnesium, uranium, and titanium are flammable and could catch on fire.
4. Cutting fluids should be treated or replaced to reduce bacterial levels which may cause illness.

